



U.S. DEPARTMENT OF
ENERGY

Pathways to Commercial Liftoff: Virtual Power Plants



SEPTEMBER | 2023



Neither the United States Government nor any agency thereof, nor any of their employees, nor any of their contractors, subcontractors or their employees, makes any warranty, express or implied, or assumes any legal liability or responsibility for any third party's use or the results of such use of any information, apparatus, product, or process disclosed, or represents that its use would not infringe privately owned rights. Reference herein to any specific commercial product, process, or service by trade name, trademark, manufacturer, or otherwise, does not necessarily constitute or imply its endorsement, recommendation, or favoring by the United States Government or any agency thereof or its contractors or subcontractors.

Comments

The Department of Energy welcomes input and feedback on the contents of this Pathway to Commercial Liftoff Report. Please direct all inquiries and input to liftoff@hq.doe.gov. Input and feedback should not include business sensitive information, trade secrets, proprietary, or otherwise confidential information. Please note that input and feedback provided is subject to the Freedom of Information Act.

Authors

Jennifer Downing, **Loan Programs Office** (*Lead*)

Nicholas Johnson, **Office of Policy**

Mailinh McNicholas, **Office of Technology Transitions**

David Nemptzow, **Loan Programs Office**

Rima Oueid, **Office of Technology Transitions**

Joseph Paladino, **Office of Electricity**

Elizabeth Bellis Wolfe, **Loan Programs Office**

Acknowledgements

Cross-cutting Department of Energy leadership for the Pathways to Commercial Liftoff effort:

Loan Programs Office: Jigar Shah, Jonah Wagner

Office of Clean Energy Demonstrations: Kelly Cummins, Melissa Klembara

Undersecretary for Infrastructure: David Crane

Office of Technology Transitions: Vanessa Chan, Lucia Tian

Office of Policy: Neelesh Nerurkar

Department of Energy advisory and support for the VPP Liftoff report:

Office of Electricity: Gene Rodrigues

Office of Energy Efficiency and Renewable Energy: Alejandro Moreno, Rebecca Albertus-Jones, Carolyn Snyder, Paul Spitsen, Ram Narayanamurthy, Julia Miller, Gabriel Klein, Garrett Nilsen, Cecilia Johnson

Office of State and Local Energy Programs: Henry McKoy, Chris Castro, Michael Forrester

Office of Cyber Security, Energy Security, and Emergency Response: Puesh Kumar, Elaine Ulrich, Christopher Sweeney

Office of Economic Impact and Diversity: Shalanda Baker, Tony Reames, Malcolm Miller, Isaac Lertola

Loan Programs Office: Sean Sevilla, Michael Schweitzer, Amy Peterson, Sandhya Jetty

Office of Policy: Carla Frisch, Noel Crisostomo, John Agan

Grid Deployment Office: Maria Robinson

Analytical support from The Brattle Group:

Ryan Hledik, Kate Peters

Table of Contents

Purpose of Liftoff reports	1
Objectives and Scope of this Liftoff report on Virtual Power Plants	1
Executive Summary	2
Chapter One: Introduction	6
1.i. Virtual power plant definition	6
1.ii. Distributed energy resource definition	6
1.iii. VPP value proposition	8
Chapter Two: Current State Technologies and Market	13
2.i. DER adoption	13
2.ii. VPP operations	16
2.iii. VPP participation in electricity markets	19
2.iv. VPP deployment by state	21
2.v. VPP business model economics	23
2.vi. An inflection point for VPPs	31
Chapter Three: Pathway to VPP Liftoff	32
3.i. VPP potential in 2030	32
3.ii. Pathway to VPP liftoff	33
3.iii. Broader implications	35
Chapter Four: Challenges to Liftoff and Potential Solutions	38
4.i. Expand DER adoption with equitable benefits	38
4.ii. Simplify VPP enrollment	41
4.iii. Increase standardization in VPP operations	43
4.iv. Integrate into utility planning and incentives	48
4.v. Integrate into wholesale markets	51
Chapter Five: Metrics to Track Progress	53

Appendix	56
I. Key concepts and terms in this report	56
II. Illustrative 24-hour electrical load curve in 2024, 2030, 2050	57
III. FERC definition of DER and DER Aggregator	57
IV. VPP Evolution	58
V. Variation across VPPs	59
VI. Enabling grid software and hardware technologies for VPPs	60
VII. Potential grid services	63
VIII. Overview of VPP Business model cost and revenue drivers	65
IX. Cost and revenue detail for example smart thermostat demand response VPP	66
X. 2030 flexible demand capacity and grid savings potential detail	67
XI. Modeling tools available from select DOE-partnered national laboratories	69
XII. Recommendations for further analysis	71
 References	 72

Purpose of Liftoff reports

Liftoff reports describe the market opportunity, current challenges, and potential solutions for the commercialization of interdependent clean energy technologies. Liftoff reports are an ongoing, DOE-led effort to engage directly with energy communities and the private sector across the entire clean-energy landscape. Their goal is to catalyze rapid and coordinated action across the full technology value chain. Reports will be updated regularly as living documents and are based on best-available information at time of publication. For more information, see [Liftoff.Energy.gov](https://liftoff.energy.gov).

Objectives and Scope of this Liftoff report on Virtual Power Plants

This report is meant for a diverse audience of stakeholders who can help accelerate liftoff for virtual power plants (VPPs). For the audience unfamiliar with VPPs, this report aims to build foundational understanding of their value proposition and the associated business models and technology in use today. Among more experienced audiences, the report aims to catalyze and organize a dialogue between DOE, state and national regulators, policymakers, utilities, ISOs/RTOs, corporations, research organizations, advocacy groups, and more around challenges and potential solutions for liftoff. Building on this report, future efforts can include near-term, no-regrets actions as well as the development of more detailed, longer-term roadmaps for the rapid, safe, equitable, and cost-effective deployment of VPPs.

This report is organized as follows:

- **Chapter 1: Introduction** defines VPPs and distributed energy resources (DERs) and summarizes the VPP value proposition.
- **Chapter 2: Current State Technologies and Market** provides an outlook for DER growth, explains foundational concepts of how VPPs operate, reviews how VPPs participate in electricity markets and current deployment trends, and presents examples of the economics of VPP business models.
- **Chapter 3: Pathway to VPP Liftoff** describes the potential opportunity for VPPs in 2030, outlines five imperatives for accelerating growth, and discusses broader implications.
- **Chapter 4: Challenges to Liftoff and Potential Solutions** discusses challenges associated with the five imperatives, priority potential solutions, and associated actions stakeholders can take.
- **Chapter 5: Metrics to Track Progress** suggests metrics for leading indicators, lagging indicators, and goal outcomes of VPP liftoff.

Executive Summary

With electricity demand growing for the first time in a decade and fossil assets retiring, deploying 80-160 GW of virtual power plants (VPPs)—tripling current scale—by 2030 could support rapid electrification while redirecting grid spending from peaker plants to participants and reducing overall grid costs. Between 2023 and 2030, the U.S. will need to add enough new power generation capacity to supply over 200 GW of peak demand;¹ were the U.S. to follow a path towards 100% clean electricity by 2035, new capacity needs could nearly double.ⁱ In all scenarios, the mix of weather-dependent renewable generation will be unprecedented, leading to more variable electricity supply and higher demand for transmission capacity. Transmission interconnection backlogs, which have stretched to an average of five years, pose potential resource adequacy challenges.ⁱⁱ Large-scale deployment of VPPs could help address demand increases and rising peaks at lower cost than conventional resources, reducing the energy costs for Americans – one in six of whom are already behind on electricity bills.ⁱⁱⁱ

VPPs are aggregations of distributed energy resources (DERs) such as rooftop solar with behind-the-meter (BTM) batteries, electric vehicles (EVs) and chargers, electric water heaters, smart buildings and their controls, and flexible commercial and industrial (C&I) loads that can balance electricity demand and supply and provide utility-scale and utility-grade grid services like a traditional power plant. VPPs enroll DER owners – including residential, commercial, and industrial electricity consumers – in a variety of participation models that offer rewards for contributing to efficient grid operations.

Virtual power plant

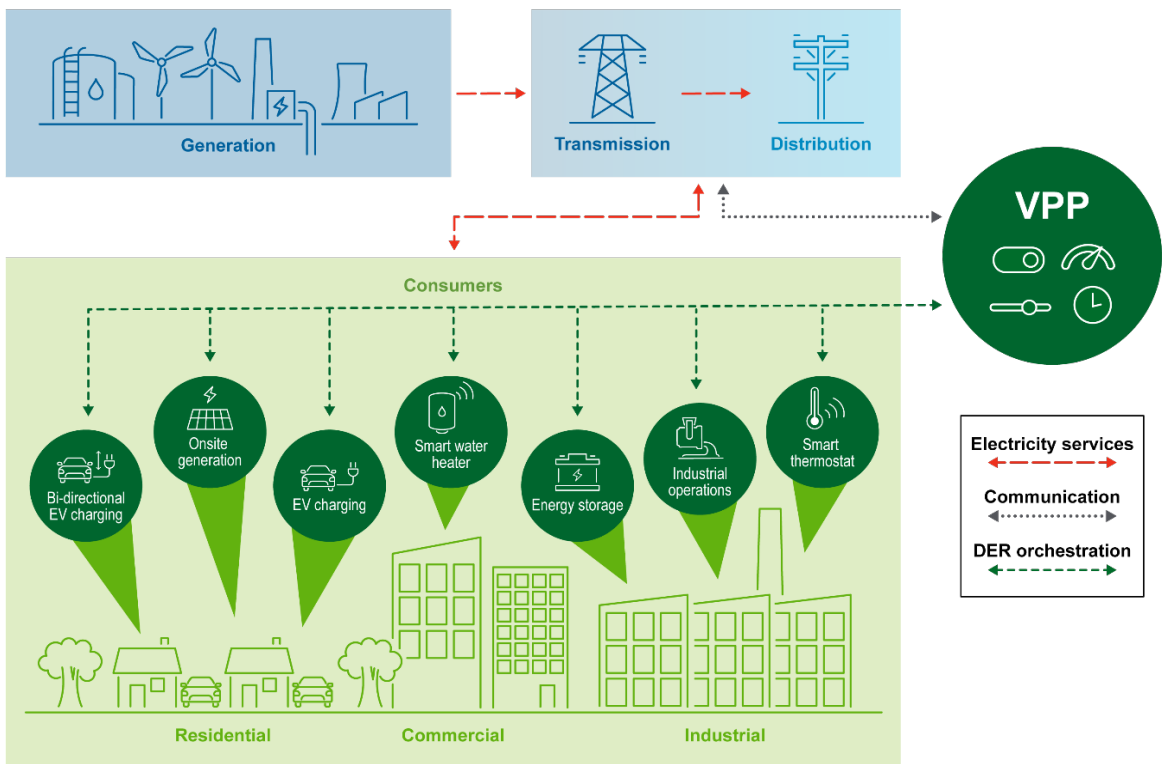

¹ Peak demand in the U.S. is expected to grow approximately 8% in the U.S. between 2023 and 2030 – from 743 GW to 802 GW—an incremental 59 GW (estimated by The Brattle Group based on total electricity consumption projections from Office of Policy National Energy Modeling System mid-case electrification scenario). It is estimated 162 GW to 183 GW of generation will be retired between 2023-2030. If retiring assets were operating at full capacity, the retirements combined with peak demand growth would imply a supply gap of 221 to 242 GW. However, the majority of recent and expected retirements are aging coal plants, with some oil and natural gas plants retiring as well; retiring assets will likely be operating below full capacity. For this reason, the need is estimated conservatively to be ~200 GW (~60 GW new peak demand + ~140 GW peak demand no longer served by assets retired).

VPPs are not new and have been operating with commercially available technology for years. Most of the 30-60 GW of VPP capacity today is in demand response programs that are used when bulk power supply is limited; these programs turn off or decrease consumption from DERs such as smart thermostats, water heaters, and commercial and industrial equipment. However, VPPs have the technical potential to perform a wider array of functions. Example functions of VPPs on the market today include shifting the timing of EV charging to avoid overloading local distribution system equipment, supplying homes with energy from on-site solar-plus-storage systems during peak hours to reduce demand on the bulk power system, charging distributed batteries at opportune times to reduce utility-scale solar curtailment, dispatching energy from commercial EV batteries back to the grid, and contributing ancillary services to maintain power quality, all while minimizing impact to the DER owner.

VPPs can contribute to resource adequacy² at a low cost; equally as important as their financial benefits, VPPs in various forms can increase resilience, reduce greenhouse gas emissions and air pollution, reduce T&D congestion, empower communities, and be adapted to meet evolving grid needs. A VPP made up of residential smart thermostats, smart water heaters, EV chargers, and BTM batteries, for example, could provide peaking capacity at 40 to 60% lower net cost to a utility than alternatives (a utility-scale battery and a natural gas peaker plant).^{iv} Rather than using natural gas peaker plants to burn fuel and transport electricity over transmission and distribution (T&D) lines, utilities can use VPPs to pay participating end-users for balancing demand on the grid locally with DERs and supporting systems.

VPP value proposition

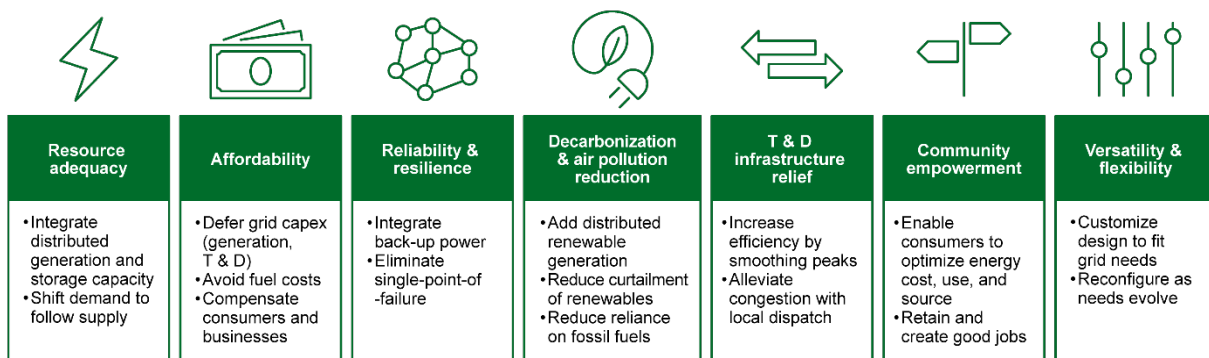

Limited integration of VPPs into electricity system planning, operations, and market participation has inhibited growth to date. Regulation-driven grid planning requirements and cost-benefit assessments undervalue the potential benefits of VPPs in most jurisdictions, deterring investment in programs and potential grid upgrades that enable VPPs. Tools and protocols for VPP planning, operations, measurement, and valuation that are necessary for utilities and regional grid operators to integrate VPPs into distribution systems and bulk power systems have emerged, but vary by service provider and jurisdiction. This complexity and fragmentation has contributed to a lack of confidence in the dependability of VPPs among utilities, which has in turn led to many years of collecting data with pilots that – despite their success – have yet to scale up.

Deploying 80-160 GW of VPPs by 2030 to help address national capacity needs could save on the order of \$10B in annual grid costs and will direct grid spending back to electricity consumers.³

At this scale, VPPs could contribute approximately 10-20% of peak demand, with local variation based on conditions such as DER availability and mix of utility-scale renewable generation. Potential DER capacity that can be enrolled in a VPP is growing at an accelerating rate, with EVs representing the vast majority of growth with highly flexible demand. Each year from 2025 to 2030, the grid is expected to add: 20-90 GW

² Resource adequacy refers to the ability of the electric grid to satisfy the end-user power demand at any given time; It is an assessment of whether the current or projected resource mix is sufficient to meet capacity and energy needs for a particular grid.

³ Savings estimates for 80 GW (\$6B) to 160 GW (\$11B) of VPP capacity are estimated based on the savings-per-GW ratios of Brattle (2023) and Clack (2021) analysis of peak-coincident flexible demand / DER capacity (est. \$0.07B per GW in both studies).

of nameplate⁴ demand capacity from EV charging infrastructure^{v, vi} and 300-540 GWh of nameplate storage capacity^{vii} from EV batteries; an additional 5-6 GW of flexible demand from smart thermostats, smart water heaters, and non-residential DER;^{viii} 20-35 GW of nameplate generation capacity from distributed solar and fuel-based generators;^{ix, x} and 7-24 GWh of nameplate storage capacity from stationary batteries.^{xi}

VPP liftoff

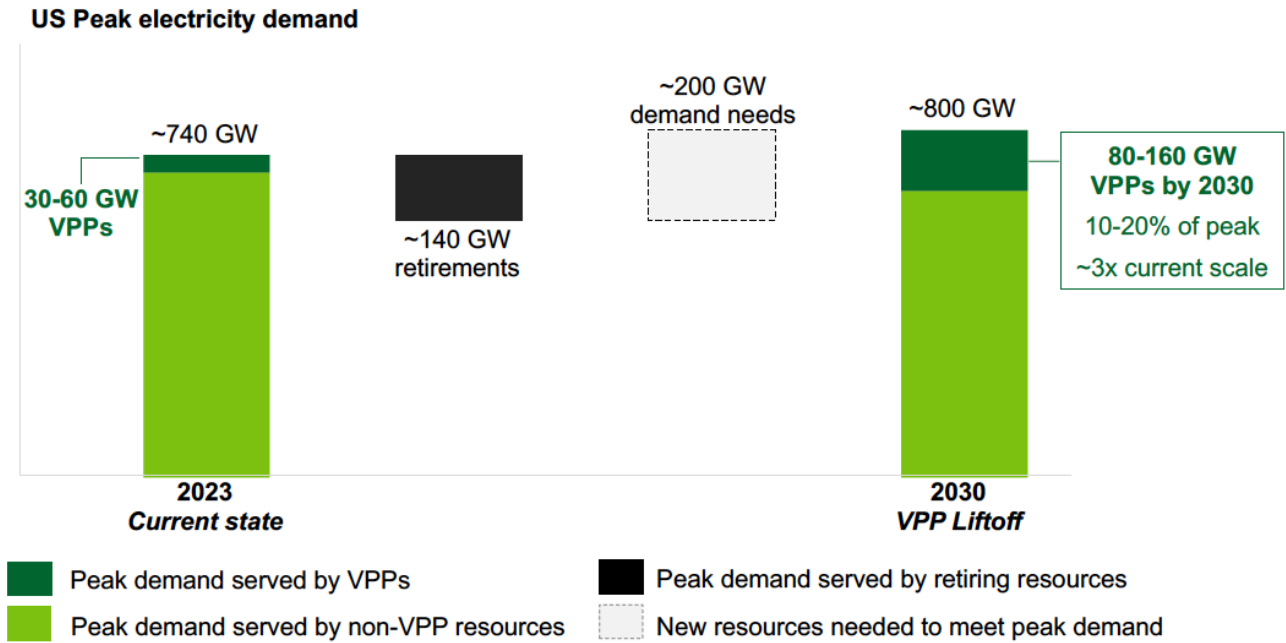

Notes: 2023 VPP capacity based on estimates from Wood Mackenzie (2023) and FERC (2021). 2030 VPP capacity potential and savings potential based on industry interviews and analysis by The Brattle Group (2023) and Clack et al. (2021). See footnote 1 for detail on asset retirements and peak growth estimates.

This report represents an urgent call to action for a diverse range of stakeholders to accelerate VPP liftoff. It is meant to initiate and organize a dialogue between the Department of Energy (DOE), other public sector leaders, and the private sector on charting the path forward. This includes progress on five imperatives.

Imperatives for VPP liftoff

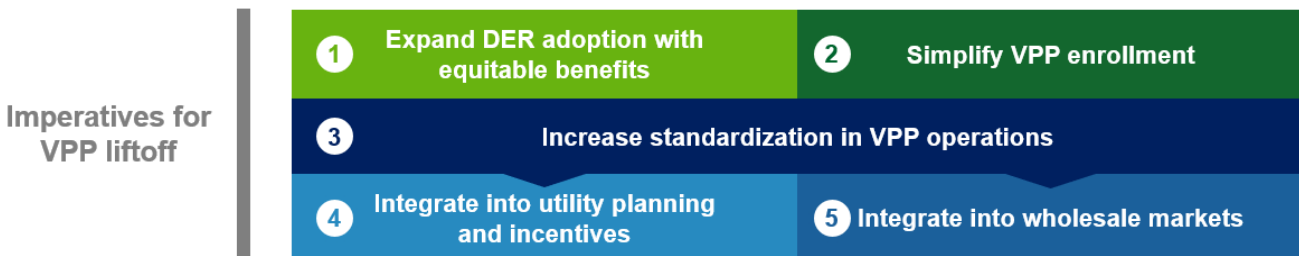

⁴ Conversion of DER nameplate capacity to DER contribution to VPP in terms of flexible demand, generation, and storage capacity varies by DER type (e.g., EV battery & EV charger contributions depend on VPP participation rates, state of charge, driving patterns, and load management approach). Estimates of capacity from smart thermostats, water heaters, and non-residential demand reflect flexible capacity.

1. **Expand DER adoption with equitable benefits:** Governments, nonprofit organizations, utilities, DER manufacturers, and VPP platforms can collaborate on holistic support for DER adoption and VPP deployment that prioritizes equitable benefits, including electricity bill savings, grid reliability and resilience, air quality improvements, and job opportunities. Offering low-cost financing and rebates for energy-efficient, VPP-enabled devices, for example, can induce consumers to shift spending on equipment or vehicle upgrades toward DERs with greater potential system benefits.
2. **Simplify VPP enrollment:** Utilities, DER manufacturers, VPP platforms, consumer advocates, and regulators can develop a phased approach to streamline VPP participant enrollment. Measures include consumer education, automatic enrollment of DERs into VPPs at the point of purchase with opt-out options, and wider VPP-enablement of DER devices.
3. **Increase standardization in VPP operations:** Private sector and public sector stakeholders can improve coordination and resourcing for the development of guidelines, standards, and/or requirements that make VPPs more repeatable and shorten the design and pilot stages of individual VPP deployments. Priority areas include improved DER and VPP forecasting tools, standardized service agreement contracts, and measurement and verification (M&V) methods. Standardization of distribution grid operations overall (i.e., including and beyond VPPs) will accelerate liftoff; key areas include distribution system reliability standards and formalized grid codes to govern system participants, DER interconnection and data standards, and cybersecurity. Increased standardization (*Imperative 3*) will accelerate VPP integration into retail and wholesale markets (*Imperatives 4 & 5*).
4. **Integrate into utility planning and incentives:** Governments, utilities, and nonprofit organizations can increase resources and personnel support for utility regulators (e.g., public utility commissions, boards of cooperatives, and more) to revise or introduce new distribution system planning requirements, procurement processes, ratemaking, and customer programs that promote cost-effective DER adoption and VPP deployment while accounting for potential necessary grid upgrades.
5. **Integrate into wholesale markets:** In restructured markets,⁵ ISOs/RTOs may benefit from targeted support for the timely and inclusive integration of VPPs into system planning and marketplaces as outlined in FERC Order 2222.

As a parallel path to scaling up existing DER and VPP technologies and business models operating today (the focus of this report), investments should continue in next-generation DER and VPP innovation.

DOE and its collaborators have over 20 complementary programs underway to accelerate VPP liftoff. Existing initiatives range from financing support for DER and VPP deployment, the development of VPP modeling and planning tools, demonstration projects, guidance on grid modernization strategies, and more. Additional initiatives may take shape in response to industry engagement that this report aims to catalyze.

⁵ See Chapter 2 for explanation of restructured markets. ISO = Independent system operator; RTO = Regional transmission operator; FERC = Federal Energy Regulatory Commission.

Chapter One: Introduction

Key takeaways

- Between 2023 and 2030, the U.S. grid will likely need to add enough new capacity to supply over 200 GW of electricity demand during peak hours.
- VPPs are aggregations of distributed energy resources (DERs) that can balance electricity demand and supply and provide utility-scale and utility-grade grid services as an alternative or supplement to centralized resources.
- By using DERs such as water heaters, EV chargers, behind-the-meter batteries and rooftop solar in different ways, VPPs can expand the grid's capacity to serve rising peak demand at a low cost.
- Equally as important as their financial benefits, VPPs in various forms can increase resilience, reduce greenhouse gas emissions and air pollution, reduce transmission and distribution system congestion, give consumers greater freedom over their electricity supply and cost, create and retain good jobs, and be adapted over time to meet evolving grid needs.

1.i. Virtual power plant definition

VPPs are aggregations of DERs that can balance electrical loads⁶ and provide utility-scale and utility-grade grid services like a traditional power plant. DOE uses a broad definition of VPPs that includes a variety of mechanisms for aggregating and orchestrating DERs, discussed in detail in Chapter 2. Fundamentally, VPPs are a tool used for flexing distributed demand and supply resources with a level of dexterity that has historically only been possible in flexing centralized supply.

Just as different types of traditional power plants contribute to the grid in different ways (e.g., nuclear plants provide baseload generation, and wind farms provide variable generation), so too do different configurations of VPPs.⁷ For example, the majority of VPPs today strictly shape the demand felt by the electrical grid by orchestrating DERs that consume electricity and/or DERs that generate and store electricity that stays behind the meter for on-site use (*demand-shaping VPPs*). A minority of VPPs supply electricity back to the grid from behind the meter (*exporting VPPs*). See appendix for a list of grid services and their definitions, and for a more comprehensive overview of variation across VPPs.

1.ii. Distributed energy resource definition

DERs are equipment located on or near the site of end-use that can provide electricity demand flexibility, electricity generation, storage, or other energy services at a small scale (sub-utility scale) and are typically connected to the lower-voltage distribution grid. In this report, DERs are grouped into three categories: demand, generation, and storage. Examples of demand DERs include EV chargers, smart thermostats paired with electric heating, ventilation, and air conditioning systems (HVAC) such as heat



⁶ The term 'electrical load' generally refers to the demand for electricity net of any locally supplied electricity from distributed generation or storage that reduce the amount of electricity the grid needs to provide from centralized assets. VPPs are distinguished from other load balancing strategies by their use of a unifying architecture that translates a set of distributed assets acting independently into one utility-scale resource that, on the whole, can be predictably incorporated into active management of grid conditions.

⁷ The term 'VPP' is used in this report to refer to a collection of different potential types of VPPs (and examples are specified in Chapter 2), but it is important to acknowledge that different VPPs will perform different services and deliver different benefits. For example, VPPs can integrate distributed solar and storage, but not all will. The value proposition of VPPs in this chapter describes what can be accomplished with different VPP configurations and is not meant to suggest that every VPP will, or should, achieve every goal.

pumps, electric water heaters, and C&I equipment. Storage DERs include BTM batteries and EV batteries. Generation DERs include distributed solar (which becomes dispatchable when paired with storage systems such as batteries) and fuel-based generators.⁸

In the vast majority of cases, consumers and companies buy and install DERs for a variety of functions unrelated to grid services; they buy EVs for transport, heat pumps for temperature control, and batteries for backup power, for example. Without undue disruption to their primary functions, DERs can be used strategically to shift demand from peak to off-peak hours, shed demand on the grid during supply shortages (either by reducing consumption or by serving consumption with an on-site DER), reshape and reduce baseload consumption, or provide ancillary services⁹ to satisfy the needs of the distribution or transmission grid. These effects are sometimes referred to as load shift, shed, shape, and shimmy.

Different types of DERs play different roles in a VPP. Four example DER types are:

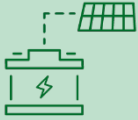
Example DER	Common use in VPPs
 <p>Smart Thermostats</p>	<p>Internet-connected temperature controls can increase or decrease electricity demand from HVAC, particularly when seasonal demand is high (e.g., hot summer afternoons and cold winter mornings.) To avoid participant discomfort, buildings and homes can be pre-heated or pre-cooled during off-peak hours, and reductions in demand can be staggered over a two to four hour window.</p>
 <p>Smart Water Heaters</p>	<p>Heat pump or resistive water heaters can be controlled remotely, for example to pre-heat water when clean energy supply is abundant or to avoid heating during peak demand. Controls may be embedded in or external to the water heater. Changes in demand timing are typically imperceptible to the owner.</p>
 <p>EV Chargers</p>	<p>Managed or ‘smart’ EV chargers in buildings, homes, and charging stations can adjust charging power levels or delay charging sessions.^{xii} Charging infrastructure may be unidirectional (charges the battery) or bidirectional (can also dispatch electricity from the battery out through the charger to a building or beyond the meter to the grid). Unidirectional chargers can time-shift demand; EV owners who leave their vehicle plugged in at home overnight, for example, will not notice changes in charge timing as long as the vehicle is sufficiently charged in the morning. Bidirectional chargers – called vehicle-to-X or V2X – may provide electricity akin to a BTM battery when an EV is plugged in.</p>
 <p>BTM Batteries (with solar)</p>	<p>Distributed battery electricity storage systems provide back-up power during grid outages. They are charged when electricity is abundant – often with clean energy from paired distributed solar generation – and dispatched when electricity from the grid is scarce. Dispatch to the building where the battery is sited reduces demand on transmission lines and intermediate infrastructure on the distribution grid, such as substations. Batteries can also provide ancillary services to balance the grid, such as frequency regulation. When energy is dispatched beyond the meter where the battery is sited (less common today), the battery can help power other assets on the local grid.</p>

⁸ The term ‘DER’ may also refer to a combination of devices, such as a microgrid. Front-of-the meter assets, such as storage systems, can also be part of VPP configurations.

⁹ Ancillary services include frequency and voltage regulation. See appendix for a list of grid services and their definitions.

Ways in which DERs can shape demand on the grid

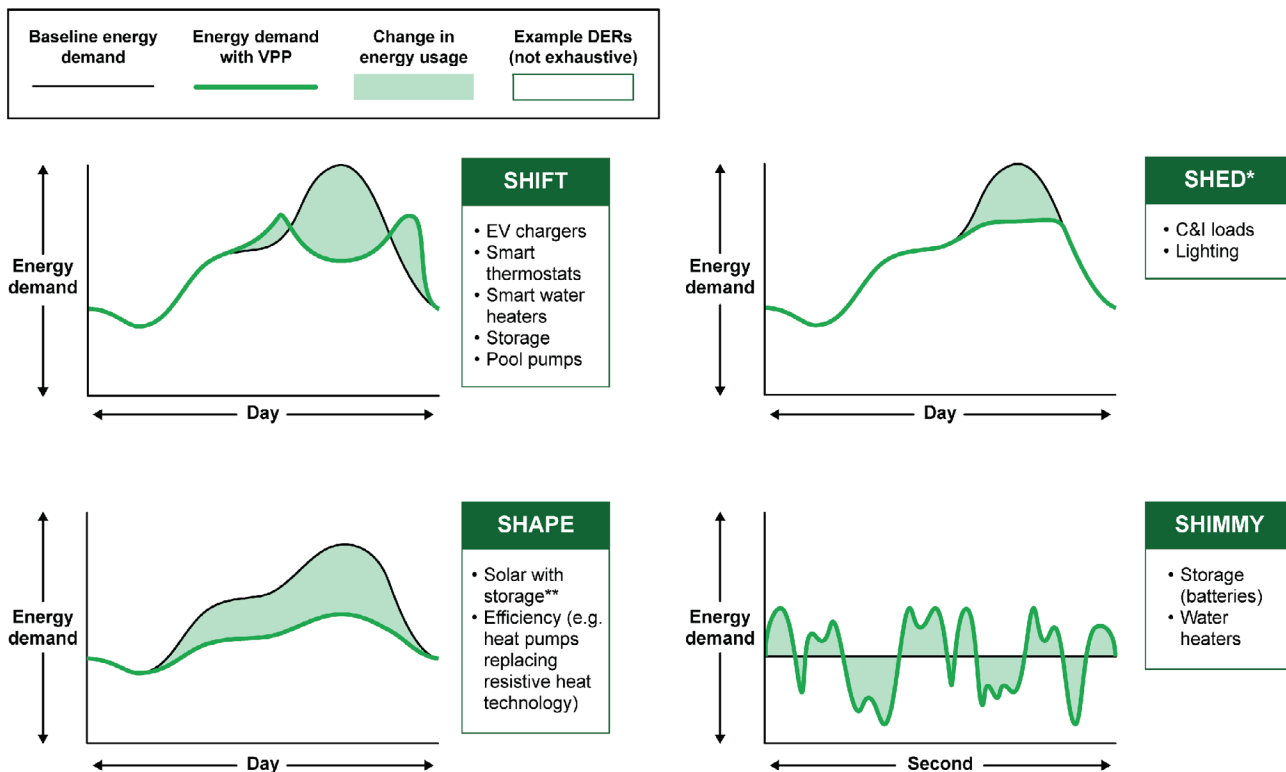

Note: *Load shed for some DERs results in load shifting to later hours as a system (e.g., HVAC) recovers from an event.
 **Distributed solar with storage reduces demand on the grid without impacting the energy consumed behind the meter.
 Source: Adapted from Lawrence Berkeley National Laboratory and NASEO-NARUC Grid-Interactive Buildings Working Group.^{xiii}

1.iii. VPP value proposition

VPPs are fit-for-purpose grid resources that can help manage high and variable demand at a low cost. The scale and composition of VPPs are highly configurable to meet the needs of the local distribution or regional transmission grid. By reshaping demand curves and providing other grid services from DERs in various models, VPPs have the potential to increase the resources and flexibility of the grid at a lower cost than centralized assets. Beyond contributing to resource adequacy and affordability, VPPs can increase resilience, reduce greenhouse gas emissions and air pollution, reduce T&D congestion, give consumers greater freedom over their electricity supply and cost, create and retain good jobs, and be adapted over time to meet evolving grid needs.

VPP Value Proposition

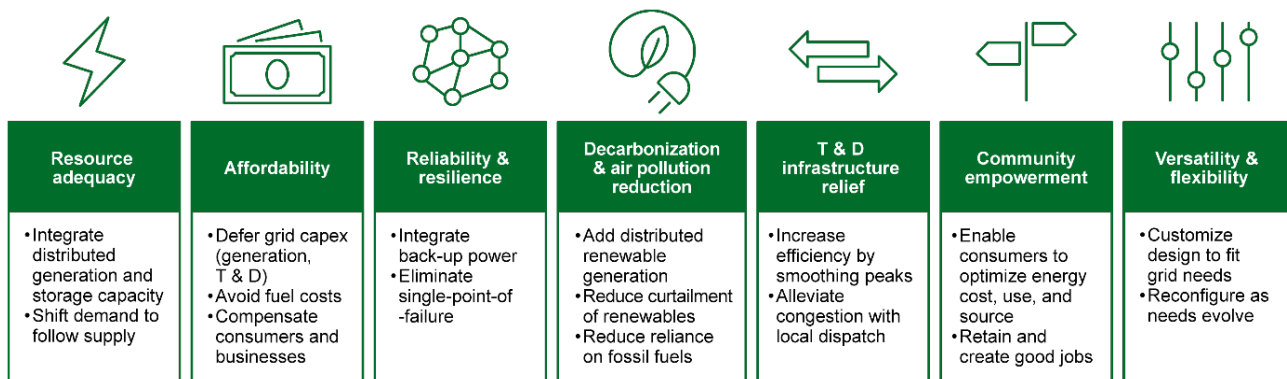

Resource adequacy

Between 2023 and 2030, the U.S. will likely need to add enough new power capacity to meet over 200 GW of peak demand;¹⁰ were the U.S. to follow a path towards 100% clean electricity by 2035, new capacity needs could be nearly double.^{xiv} In all scenarios, the mix of weather-dependent renewable generation will be unprecedented, leading to more variable electricity supply and higher demand for transmission capacity. Combined with demand growth from electrification and anticipated generation asset retirements, interconnection backlogs—which have stretched to an average of five years^{xv}—pose potential resource adequacy challenges.

VPPs can increase the grid’s capacity to serve growing electricity consumption by shifting or shedding demand to shrink peaks and reduce the need for peaking generation assets. They can also add distributed generation capacity and distributed storage capacity into grid operations – for example, from rooftop or community solar with storage DERs. VPPs can address system constraints at both the transmission level (e.g., reduce peaks when supply from utility-scale generation resources is limited) and distribution level (e.g., reduce peak demand that threatens to exceed the safety limits of local equipment).

¹⁰ Peak demand in the U.S. is expected to grow approximately 8% in the U.S. between 2023 and 2030 – from 743 GW to 802 GW—and incremental 59 GW (estimated by The Brattle Group based on total electricity consumption projections from Office of Policy National Energy Modeling System mid-case electrification scenario). It is estimated 162 GW to 183 GW of generation will be retired between 2023-2030. If retiring assets were operating at full capacity, the retirements combined with peak demand growth would imply a supply gap of 221 to 242. However, the majority of recent and expected retirements are aging coal plants, with some oil and natural gas plants retiring as well; retiring assets will likely be operating below full capacity. For this reason, the need is estimated conservatively to be ~200 GW.

U.S. system peak demand, historical and projected, GW (1995-2050E)

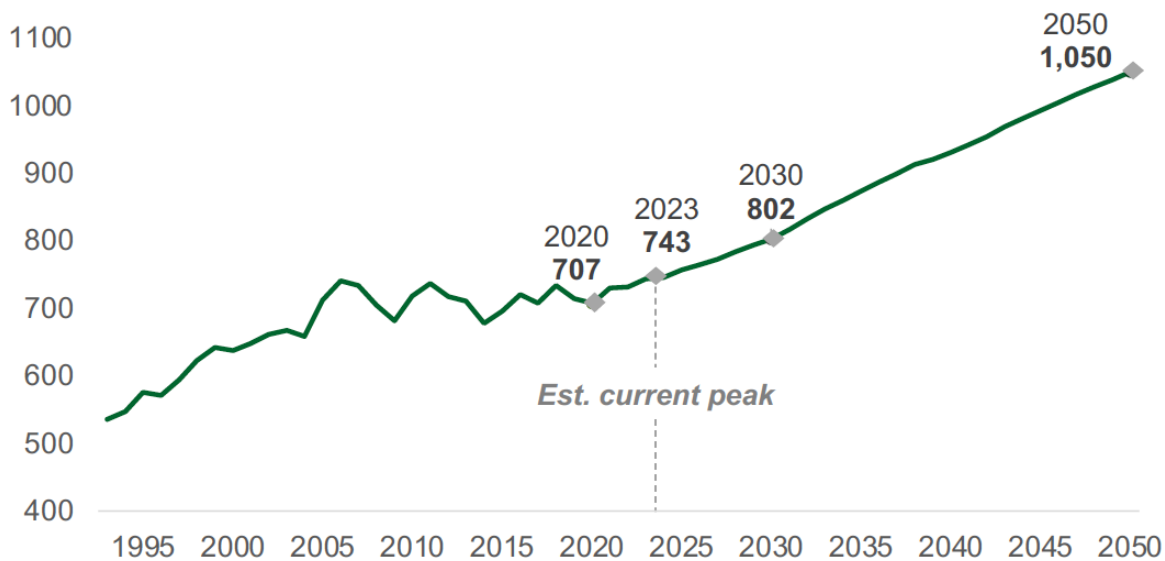

Note: National coincident peak demand is based on sum of peaks across FERC regions.

Source: Historical energy demand sourced from AEO. Coincident peak demand (point-in-time peak, not total energy consumption) estimated by The Brattle Group (2023) based on forecasted total energy consumption sourced from OP-NEMS mid-case scenario. This mid-case scenario includes increasing consumption from industrial electrification and electrification of HVAC; however, the EVs contribute the most demand to coincident peak according to estimated hourly consumption patterns that will vary by region.

Affordability

At the end of January 2023, over 20 million American households – one in six – were behind on electric bills.^{xvi} As lower-cost options for increasing grid capacity, VPPs can moderate the cost burden on ratepayers. They provide services from DERs available on the distribution grid in ways that can be more cost-effective than increasing bulk system resources. Procuring new peak capacity from a VPP comprised of residential smart thermostats, smart water heaters, home managed EV charging, and BTM batteries can be 40% lower net cost to a utility than procuring new capacity from a utility-scale battery and 60% lower net cost than a natural gas peaker plant, according to a study of a representative utility system in 2030.^{xvii} The VPP incurs the lowest associated T&D costs of the three resources modeled because the VPP reduces peak demand and the associated strain on T&D (rather than increasing the supply of electricity running through the T&D system). Accounting for the societal value of emissions reductions would further advantage VPPs.

Jurisdiction-specific studies in multiple states have demonstrated the potential to reduce grid costs with VPPs and related programs that rely on DERs. In California, where electrification and decarbonization are progressing rapidly, analysts estimate that required distribution grid investments may be up to \$50 billion by 2035, but could be as much as ~70% lower (as low as \$15B) if measures are taken to manage flexible demand.^{11, xviii, xix} In Texas, where peak demand grew by 9% from 2018 to 2022, analysis suggests that wider deployment of demand management with smart thermostats, heat pumps, EV charging, water heaters, and other DERs could save customers over \$150 per year on average by 2030 and achieve more reliable service.^{xx} In New York, distribution system upgrade costs required for transportation electrification are estimated to be \$1.4 billion if EV charging is managed and \$26.8 billion if not (net present value).^{xxi}

11 The California Public Utilities Commission estimated up to \$50 billion will be needed for distribution grid investments by 2035 if new measures are not taken to manage flexible demand. Subsequent preliminary research by the California Public Advocates Offices suggested that lower peak achieved with more even EV charging demand throughout the day would decrease investment costs to \$15-20B by 2035.

More cost-effective use of grid resources will help reduce energy bills for all consumers. In addition to benefitting from avoided grid costs, Americans will benefit from spending on VPPs because the majority of VPP costs flow to participating energy consumers in the form of incentive payments (instead of paying for fuel and capital investments in utility-scale infrastructure).

Net cost to a utility of procuring peaking capacity, Net cost per kW-yr

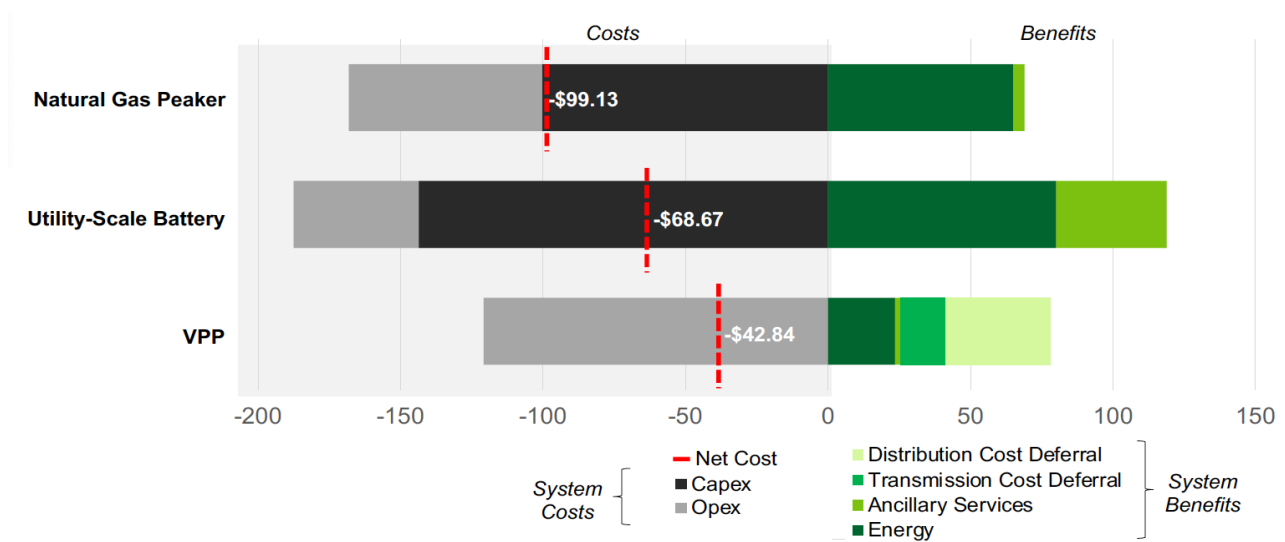

Note: Net cost to a utility of procuring 400 MW of peaking capacity are shown in \$/kW-yr in 2022 dollars. In the chart, the deferred T&D costs are represented as benefits of the VPP. Benefits of emissions reduction and resilience are not shown; when included, VPP net cost is lower, though actual emissions impact will vary by local grid mix. VPP in analysis consists of smart thermostats, smart water heating, home managed EV charging, and BTM battery demand response. Utility studied is assumed to have 50% renewable generation mix, with resource adequacy needs in summer and winter. DER penetration assumptions and VPP participation rates reflect national averages and utility experience. 8760 hours were considered and resources must be able to operate in 63 peak hours (when top 400 MW are needed) spanning 7 months, for 7 consecutive hours at a time. Costs exclude enabling grid software and hardware such as sensors and metering that would also contribute non-VPP services such as reducing reliance on meter readers, enabling time-varying rates, and data collection for energy use analytics. For detail on enabling grid software and hardware, see appendix Source: The Brattle Group, [Real Reliability: The Value of Virtual Power](#) (2023).

Reliability & resilience

Between 2011 and 2021, the average annual number of weather-related power outages in the U.S. increased by roughly 78% compared to 2000-2010.^{xxii} In spring of 2023, the North American Electric Reliability Corporation (NERC) issued its highest alert level ever, urging generation and transmission owners to take measures to prepare for extreme winter conditions, including plans for customer demand management to prevent uncontrolled load shedding and cascading outages.^{xxiii}

Resource adequacy is central to grid reliability, and VPPs contribute in ways described above. Several potential characteristics of VPPs can further increase resilience: a geographically diverse footprint of generation sites, a higher number of storage assets, and the ability to ‘island’ sections of the grid into microgrids in response to adverse events such as extreme weather and other threats.

Decarbonization & air pollution reduction

Two-thirds of fossil fuel-powered peaker plants in the U.S. are located near communities with a higher percentage of low-income households than national average, and nitrogen oxide emissions rates are higher for peakers located near these communities.^{xxiv} Factors like these demonstrate that the transition to clean energy is both a climate imperative and an energy justice imperative.

VPPs have the potential to avoid greenhouse gas emissions and reduce air pollution through several mechanisms. By shifting demand from peak hours served by peaker plants to off-peak hours served by solar, wind, or nuclear, they can reduce emissions from peaker plants and reduce curtailment of utility-scale clean generation. This can increase the yield on investments in clean assets and as a result increase their deployment long-term. Additionally, they can reduce reliance on fossil baseload generation by adding distributed renewable generation resources paired with distributed storage.¹²

Transmission and distribution infrastructure relief

Regional transmission capacity would need to increase by 26-119% across U.S. regions by 2035 to meet projected generation and demand growth.^{xxv} At the same time, transmission interconnection backlogs for generation assets have extended average time spent in queues to 5 years.^{xxvi} Utilities face similar challenges managing distribution system constraints, particularly in service areas with high DER growth.

VPPs can help overcome T&D congestion challenges, especially in high load conditions, and increase overall grid efficiency by reducing and shifting peak loads.^{13, xxvii} This in turn can help defer or avoid the need to upgrade equipment and/or can support higher DER adoption on the local distribution system with existing equipment.^{xxviii} With a more consistent flow of power, T&D assets can achieve higher average utilization. When VPP aggregations of DERs in high-load areas dispatch electricity from distributed generation or storage assets, local demand can be met with less power traveling over transmission lines, further reducing line congestion.

Community empowerment

VPPs offer opportunities for consumers to contribute local resources to the reliability and resilience of their local electricity grid, and to the broader clean energy transformation. Participation is, and will continue to be, a decision made by individual energy consumers who have the freedom to optimize between cost, convenience, and source of energy.^{14, xxix}

Aggregating the installation and servicing of DERs as part of VPP deployments also presents an opportunity for utilities to establish the labor market conditions for more stable, predictable, and higher-paying jobs than the disaggregated DER industry. This contributes to ensuring new positions are good jobs^{xxx} and creates pathways for incumbent utility workers to move into VPP implementation, thus retaining their skills and expertise in the evolving power sector.

Flexibility & versatility

The opportunities and challenges facing utilities and regional grid operators are highly location-specific and rapidly evolving. At a regional level, grid operators have diverse priorities, such as adding storage capacity to complement an increasing mix of wind and solar generation (e.g., California, Texas)^{xxxi} and increasing transmission capacity for balancing supply and demand across distances (e.g., the Midwest)^{xxxii, xxxiii} At a local level, utilities are seeing demand increase at varying rates across communities in response to local electrification policies (e.g., New York)^{xxxiv, xxxv} and are managing equipment constraints on a neighborhood or even household level.

VPPs have the potential to address and overcome the shifting challenges of a rapidly evolving grid by acting as a highly configurable and ever-adaptable resource. Based on the availability of DERs in the relevant service area, the mix and size of VPP portfolios can be designed to deliver a range of grid services tailored to the time, location, and scale that is most valuable. Even after a VPP has been established, the portfolio—and how it operates—can be adapted to meet changing grid needs.

12 Locally delivered power also experiences less transmission line loss than electricity traveling longer distances, which further reduces the amount of energy generation required for a given amount of demand.

13 For example, an analysis of 5,000 Southern California Edison customers' electricity consumption and commuting behavior suggests that residential peak loads can be completely balanced by time-shifting overnight EV charging when participating EVs comprise 10% of total vehicles.

14 For example, in 2022, Nimiipuu Energy - a utility co-op operated by the Nez Perce Tribe - announced plans to reduce reliance on outside energy sources by installing and aggregating a growing number of distributed energy systems into a VPP.

Chapter Two: Current State Technologies and Market

Key takeaways

- VPPs are not new; they operate today (est. 30-60 GW nationally) with commercially available technology and are concentrated in states with favorable regulatory frameworks and market structures.
- Accelerating increases in new non-residential DERs dramatically increases the potential capacity that VPPs can aggregate. Each year from 2025 to 2030, the grid is expected to add: 20-90 GW of nameplate demand capacity from EV charging infrastructure and 300-540 GWh of nameplate storage capacity from EV batteries; an additional 5-6 GW of flexible demand from smart thermostats, smart water heaters, and non-residential DER; 20-35 GW of nameplate generation capacity from distributed solar and fuel-based generators; and 7-24 GWh of nameplate storage capacity from stationary batteries.
- Rather than viewing the massive adoption of EVs and other DERs as load to serve, utilities can view this as an opportunity to increase the flexibility of the grid.
- A wide range of innovative and financially viable VPP business models have emerged among VPP companies, utilities, DER manufacturers, and software platforms, as industry actors recognize the value creation opportunity.
- Across business models, the majority of VPP cost comes from payments to participants; revenues vary widely by grid service, off-taker, and jurisdiction.

Current flexible capacity of VPPs nationally is estimated to be 30-60 GW, though market data is limited and estimates vary by VPP definition.^{15, xxxvi, xxxvii} Deployment relies on the availability of VPP-enabled DERs combined with market structures and regulations that allow VPPs to participate and account for their system value fairly. This chapter presents the current state of the market in terms of DER adoption trends, generalizable elements of VPP operations, the different ways VPPs are currently participating in power markets, and influential regulatory factors. Simplified business model examples are provided from real, financially viable VPPs operating today.

2.i. DER adoption

The U.S. is experiencing unprecedented growth in DER adoption across households and businesses, which dramatically increases the potential capacity that VPPs can aggregate.¹⁶ This growth in DER adoption is occurring across DERs that *generate, demand, and store* electricity. Each year from 2025 to 2030, the grid is expected to add: 20-90 GW of nameplate¹⁷ demand capacity from EV charging infrastructure^{xxxviii, xxxix} and 300-540 GWh of nameplate storage capacity^{xl} from EV batteries; an additional 5-6 GW of flexible demand from smart thermostats, smart water heaters, and non-residential DERs;^{xli} 20-35 GW of nameplate generation capacity from distributed solar and fuel-based generators;^{xlii, xliii} and 7-24 GWh of nameplate storage capacity from stationary batteries.^{xliv}

15 Most market studies estimate demand response capacity in either wholesale markets (FERC 2021: 32 GW) or retail markets (EIA 2021: 29 GW), which cannot be summed due to potential double-counting. Estimates of flexible capacity under management by the top 10 VPP companies is 28 GW (according to Wood Mackenzie Grid Edge Services, 2023).

16 Increased *density* of DERs has the additional benefit of enabling more localized load management to meet the needs, or overcome constraints, of distribution systems. Diffuse DER aggregations typically target bulk power/transmission system needs.

17 Conversion of DER nameplate capacity to DER contribution to VPP in terms of flexible demand, generation, and storage capacity varies by DER type (e.g., EV battery & EV charger contributions depend on VPP participation rates, state of charge, driving patterns, and load management approach). Estimates of capacity from smart thermostats, water heaters, and non-residential demand reflect *flexible* capacity.

Annual DER capacity additions: Generation, Flexible demand, Storage (2020-2030E)

Nameplate generation capacity additions, GW

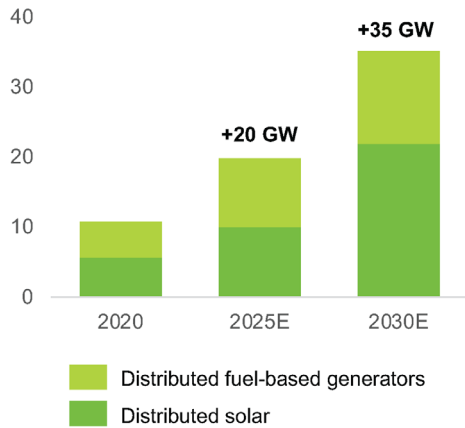

Note: Conversion of DER nameplate capacity (generation, demand, or storage) to DER contribution to VPP capacity varies by DER type. See appendix for clarification of key concepts and terms.

Source: WM refers to "Wood Mackenzie Power & Renewables"; Solar: NREL dGen (capacity growth), WM (capacity); "Mid-case, no nascent techs, current policies" scenario used for solar capacity growth projections; Fuel-based generation: OP-NEMS (capacity growth), WM (capacity); Non-resi. flexible demand: WM (capacity); Resi. ST flexible demand: WM (capacity); Resi. WH flexible demand: WM (capacity); BTM battery storage: BNEF (capacity).

Capacity from EVs (including both charging demand and storage potential) is growing fastest, increasing the overall flexibility of demand as total consumption increases. Chargers demand electricity intermittently; to

convert nameplate EV charger capacity (shown in the chart) to an estimate of flexible EV charging demand capacity that a VPP could manage, one must consider the charging patterns of EV drivers, including when the EV is plugged in and whether the charge timing is flexible vs. inflexible.¹⁸ This will vary by charger type, location (e.g., workplace, home), and market segment (e.g., commercial fleets, personal vehicles).^{xiv} Overnight charging at home or daytime charging at workplaces are examples of demand that can more easily shift hours vs. fast-charging at roadside stations that is less flexible. Similar factors apply to the nameplate capacity of EV batteries and its relationship to potential VPP capacity. For example, an EV battery's ability to absorb energy at a strategic time (e.g., when a utility has excess clean electricity), will depend on its current state of charge and whether it is plugged into a charger. An EV battery's ability to dispatch stored energy (either to a building or back to the grid) will depend on whether it is plugged into a charger with bidirectional capabilities.¹⁹ There are additional considerations for bidirectional EV chargers; for example, the electrical infrastructure supporting the charger must support injection from the EV back to the grid. Otherwise the energy must stay behind the meter.²⁰

Flexible demand capacity additions, GW

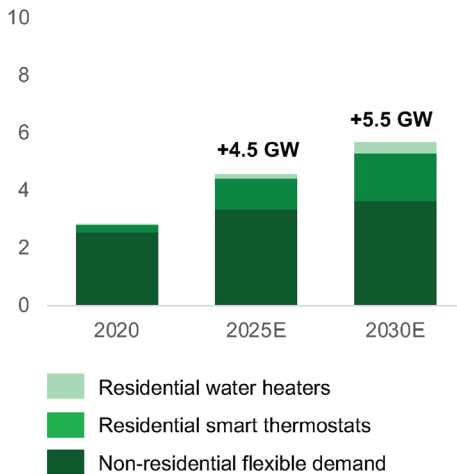

Nameplate storage capacity additions, GWh

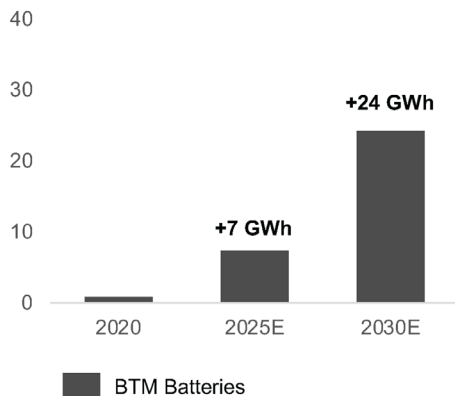

18 Predictability of charging patterns is important to help inform how EVs can create value as part of VPPs, and EV charging-related data sets are growing to provide insight into driver behavior and duty cycles. Modeling tools are also improving to help incorporate EV charger and battery capacity into grid planning and to better understand the costs and benefits associated with bidirectional charging (which requires more expensive infrastructure than unidirectional charging).

19 Estimates of the present or future ability of national EV charging infrastructure to dispatch energy from an EV battery (V2X) is not included in this report and is an important area for future analysis. Bidirectional chargers are typically found in L2 or higher capacity charging systems, which tend to have the necessary hardware and communication protocols to enable bidirectional power flow. Based on preliminary analysis at DOE, there do not appear to be L1 chargers on the market that provide V2X energy dispatch.

20 In 2021, the California Joint Agencies Vehicle-Grid Integration Working Group developed a Use Case Assessment Database that identifies and ranks use cases for light-duty vehicles and medium-to-heavy-duty vehicle V2X applications in California.

Annual EV charger and EV battery capacity additions: Demand, Storage (2020-2030E)

Nameplate demand capacity additions, GW

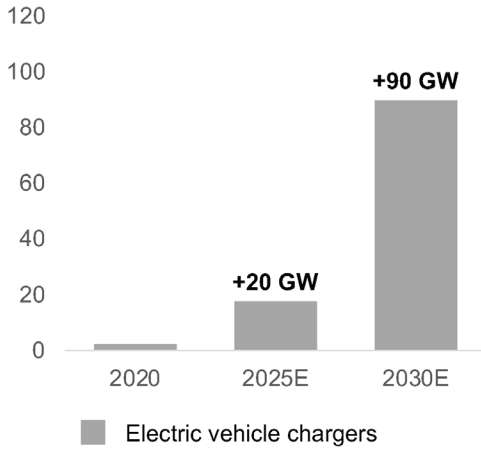

Nameplate storage capacity additions, GWh

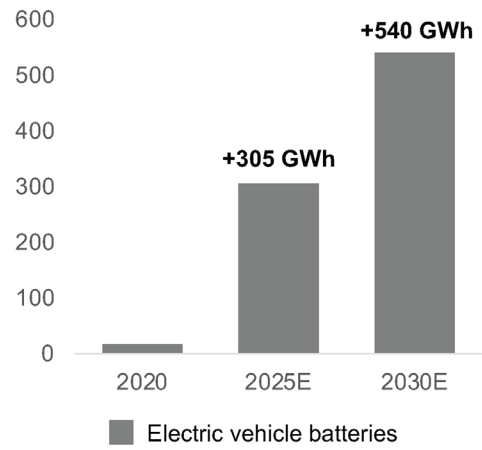

Source: WM refers to “Wood Mackenzie Power & Renewables”; EV chargers: NREL (Number of ports); DOE AFDC (Capacity per port); EVs: EERE/NREL/ORNL (non-resi. EV capacity/DER); EIA (2019 LDV EVs); EV-Database (resi. EV capacity/DER); Kelley Blue Book (resi. EV price); OP-NEMS (EV stock); VTO (non-resi. EV price).

Expected DER adoption represents investment of \$290-505 billion per year in EVs,^{xlvi} and \$50-105 billion per year (2025-2030) in other DERs^{xlvi, xlviii, xlix} across residential and non-residential settings.

Spending by consumers and businesses on DERs – e.g., water heaters, HVAC systems, vehicles – is most often for equipment replacements or upgrades, not an incremental purchase. Choosing the efficient electric DER (e.g., heat pumps, heat pump water heaters, EVs) in place of the lower-efficiency or fossil fuel-powered equivalents can reduce recurring energy bills and reduce air pollutants, increasing long-term value to the consumer. When DERs are VPP-enabled and enrolled, compensation for providing grid services can further offset the DER cost and increases the consumer’s return on investment.^{21, 1}

Annual projected investment in DERs, \$B (2020-2030E)

In-year investment in EVs, \$B (2020-2030E)

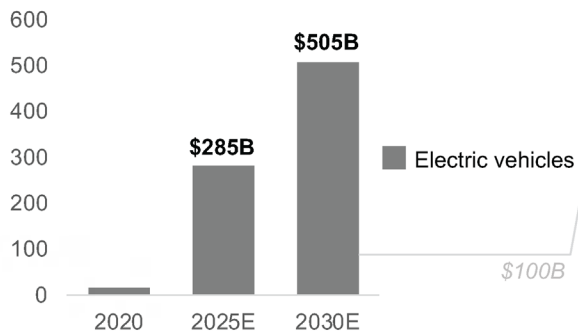

In-year investment in DERs (non-EVs), \$B (2020-2030E)

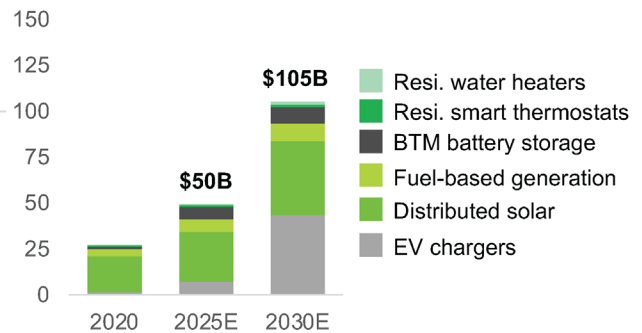

Note: Non-residential flexible demand not included in investment projections due to the complexity of estimation; Median prices used for solar & battery storage; “Mid-case, no nascent techs, current policies” scenario used for solar capacity growth projections; Non-resi demand flex. investment not included due to inability to precisely calculate; EV investment based on 2022 prices, which are kept constant; BTM battery storage investment calculated by taking average of different sources’ CAPEX estimates; EV charger estimates

21 For example, Shifted Energy, a VPP operator with a performance-based capacity contract in Hawaii, worked with community organizations and electricity customers to replace old, low-efficiency water heaters in low- and moderate-income households with high-efficiency heat pump water heaters, saving participants hundreds of dollars per month on electricity bills. By enabling controls and enrolling these appliances into their VPP during installation, participants were able to increase their savings and mitigate the risks of future changes to their electricity bills. The payback period for the new water heater was as short as one year for participants.

based on NREL projections for 2025 and 2030 charging port count, NREL estimates of equipment and installation costs, and DOE AFDC capacity estimates.

Source: WM refers to “Wood Mackenzie Power & Renewables”; Solar: LBNL (\$/W, price changes), NREL dGen (capacity growth), WM (capacity); “Mid-case, no nascent techs, current policies” scenario used for solar capacity growth projections; Fuel-based generation: OP-NEMS (capacity growth), WM (capacity, CAPEX); Non-resi. flexible demand: WM (capacity); Resi. ST flexible demand: WM (capacity, CAPEX); Resi. WH flexible demand: WM (capacity, CAPEX); BTM battery storage: BNEF (capacity), LBNL (\$/W, price changes), NREL (\$/KW), PNNL (\$/kWh), WM (CAPEX); EVs: EERE/NREL/ORNL (non-resi EV capacity/DER); EIA (2019 LDV EVs); EV-Database (resi EV capacity/DER); Kelley Blue Book (resi EV price); OP-NEMS (EV stock); VTO (non-resi EV price); EV chargers: NREL (Number of ports, CapEx per port); DOE AFDC (Capacity per port).

Every purchase is an opportunity to enroll (or pre-enroll) a DER owner in a VPP. If—after a period of expanded consumer education—VPP enrollment for the subset of DERs captured above were streamlined such that half of DERs purchased 2025–2030 joined a VPP, this would imply enrolling roughly 85 GW of nameplate generation, 15 GW of flexible demand, 135 GW of nameplate demand from EV chargers, 42 GWh of BTM storage capacity, and 1445 GWh of nameplate storage from EV batteries. Customers who do not yet have VPP participation opportunities in their service area could pre-enroll in potential future programs. New enrollment of existing DER capacity installed pre-2025 would further expand VPP capacity. For example, flexible C&I loads have been estimated to be as high as 300 GW today,^{li} though the cost-effectiveness of shifting or shedding such demand will vary by industry and based on local grid conditions and constraints.

2.ii. VPP operations

Innovative and diverse VPP models have emerged among VPP companies, utilities, DER manufacturers, and software platforms, as market actors recognize the value creation opportunity.

Elements common across VPPs include: an aggregation of DERs enrolled by participants, a mechanism for orchestrating electrical demand, generation, and/or storage from DERs using a common architecture, and one or more measurable grid services provided by the DER aggregation that can be sold, traded, recognized, or otherwise used by transmission and/or distribution grid operators to support grid management.

DER aggregation

VPPs can be made up of a single type of DER (e.g., EV chargers) or a portfolio of different DER types (e.g., microgrids with distributed generation and storage). DER owners agree to enroll and participate in a VPP under various program-specific terms. The most common types of DERs enrolled in VPPs historically have been residential smart thermostats and C&I equipment,^{liii} though increasingly diverse arrays of DERs are part of active VPPs today. *See appendix for a summary of VPP evolution.*

Companies across the energy sector are playing a role in DER aggregation; three primary models have emerged. Under the first model, the entity responsible for enrolling DER-owning customers is a utility that serves their electrical load. In this scenario, the utility will reach out to customers and offer to enroll their existing DERs and/or offer DER purchase subsidies as enrollment incentives. Examples of utilities operating VPPs include Green Mountain Power’s battery VPP and Duke Energy’s managed EV charging VPP. Utilities who aggregate DERs of their own customers may operate the VPP in-house or partner with a third-party service provider to operate the VPP. ConnectedSolutions is a New England VPP operated by multiple utilities with support from VPP platform company EnergyHub, in which residential and non-residential customers can enroll a variety of DERs.^{liiii}

In the second model, the manufacturer or retailer of the DER who sold it to the customer takes responsibility for enrollment and management of customers. DER companies that have launched VPP platforms include EV makers Tesla, Ford, and GM, and distributed solar and storage companies Sunrun and Sunnova. Under the third model, a VPP platform company enrolls DERs, which may include multiple different types and brands aggregated into a single portfolio. Voltus, AutoGrid, and Leap, for example, recruit participants, directly or via partnerships, with a variety of DERs in residential and non-residential settings. In some instances, the DER aggregator contracts with a separate ‘market interface’ provider to facilitate participation in wholesale markets, where the rules and requirements vary by region.

DER installers and servicers can play a supporting role in enrolling customers in each of these three models, even if not involved in VPP operations on an ongoing basis. For example, VPP platform company Swell collaborates with battery installers as well as manufacturers and utilities to market opportunities for VPP participation. In this mutually beneficial arrangement, the prospect of rewards paid by Swell helps deploy more solar and batteries that drive installation and service business.^{iv}

DER orchestration

The ways in which DERs are orchestrated to provide grid services has been a major source of innovation in recent years, largely enabled by increasing Wi-Fi, Bluetooth, and cellular data connectivity of DERs. Decades ago, utilities made phone calls to large industrial customers for demand management requests or directly controlled air conditioning units and water heaters of participating customers using hard-wired switches extending from the distribution grid into homes. For example, New Hampshire Electric Co-op began offering an interruptible water heating program in 1979 that continues to reduce residential electricity bills.^{iv} Today, DERs are increasingly app-enabled and can be controlled remotely with software solutions. VPP operators orchestrate DER behavior using an information technology (IT) platform that can connect to DERs at different points in the electrical chain. For example, EV charging demand can be controlled using software interfaces of the vehicle, the charger, or the smart electrical panel in the host building or charging station.²²

Communication between the VPP operator and DER can take several forms. Some VPP operators signal directly to the DER—e.g., as part of its VPP platform, Google Nest can schedule adjustments to heating and cooling demand through its connected smart thermostat software. Others send signals to the DER owner to make manual adjustments—e.g., VPP platform company OhmConnect messages its participants and relies on behavior change in some of its VPPs. These signals may take place infrequently—i.e., only during critical demand peaks—or on a daily basis to support grid operations.

Communication, control, and measurement of DER behavior is enabled by a combination of technologies provided by both DER service providers and utilities. Active management of DERs requires systems (often called DER management systems, or DERMS) that balance the demand and supply of electricity in real time, provide ancillary services, provide visibility and data exchange between the grid operators and VPP operators, and provide needed protection to utility and customer equipment. The integration of DERs into utility IT systems can enhance a utility's situational awareness of the state of the distribution grid. *See appendix for a list of enabling hardware and software.*

²² The fragmentation of control over a DER's demand can pose challenges to managing grid services while protecting the EV owner's interests, for example, if the signals sent to an EV battery are in conflict with signals sent to an EV charger. The issue of fragmented control can apply to other DERs and underscores the need for coordination among parties operating on the distribution grid, discussed in Chapter 4.

VPP operational model

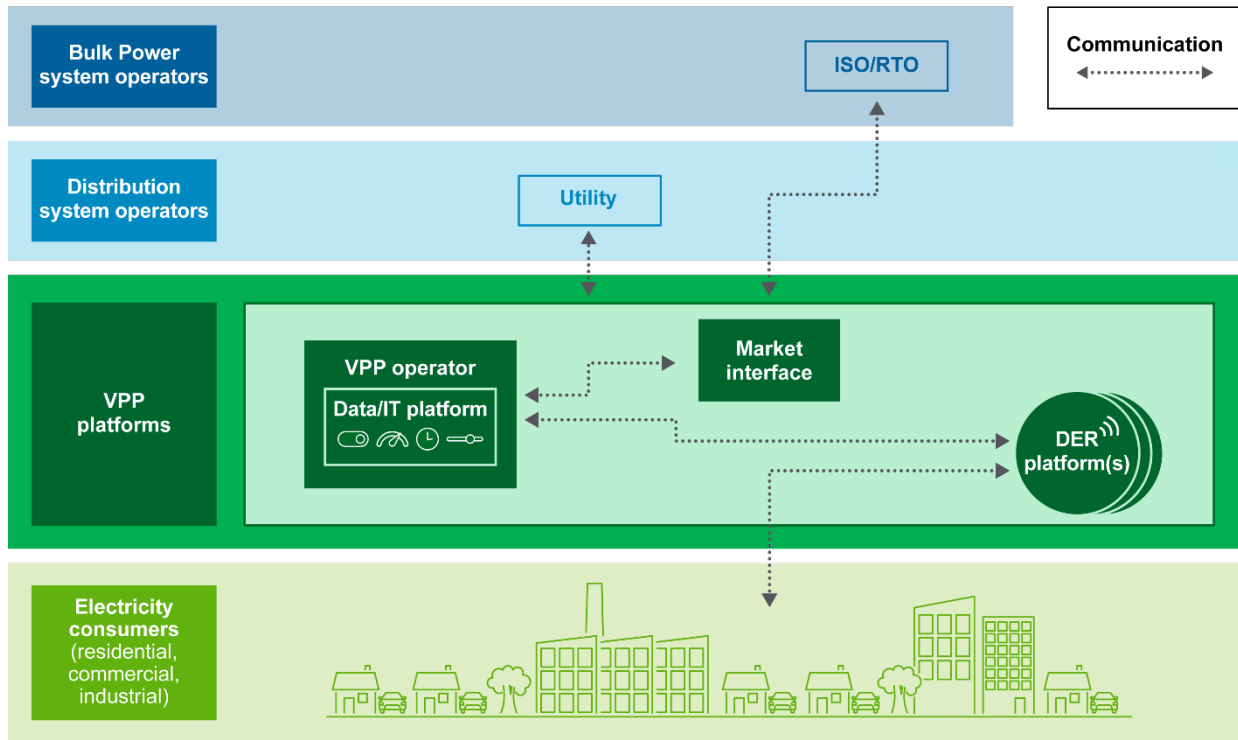

	Data/IT Platform of VPP Operator	Market interface	DER platforms
Examples (not exhaustive)	AutoGrid CPower Nest OhmConnect swell TESLA sunrun voltus	AutoGrid CPower OhmConnect RECURVE swell voltus	AutoGrid CPower Nest swell sunrun TESLA voltus

VPP services

The grid services a VPP can provide vary based on its composition of DERs and orchestration capabilities. The most common grid services (sometimes called 'products') VPPs sell are:

- **Energy**, measured per MWh delivered in the form of electricity demand reduction or electricity supply;
- **Capacity**, measured per MW of a forward energy option; and
- **Ancillary services** that support power quality, which are measured in service-specific ways.

The most common way that VPPs provide energy today is to reduce demand during supply-constrained hours – called demand response. As simple as it seems to dial down or turn off electricity-consuming equipment, the critical role that demand response plays in ensuring grid reliability cannot be overstated.²³ During California’s 2022 heat wave, for example, VPPs helped avoid rolling blackouts by delivering hundreds of megawatts of demand reduction when supply resources were scarce.^{lv}

In addition to decreasing demand during supply-constrained hours, VPPs can also *increase* demand during times of excess supply—e.g., by charging batteries or turning on EV chargers. Often called capacity building, this service is particularly valuable in locations where certain hours of the day experience an excess of supply from renewable resources that are variable or nuclear resources that are hard to turn down.

VPP service providers predict the available capacity from the DER aggregation for any given hour, day, or event based on historical and forecasted DER and electricity usage by the owner. VPP performance modeling uses large historical electricity datasets paired with probabilistic models of future electricity consumption. This ability to predict DER usage, including responses to signals from VPP operators, is critical to the reliable dispatch of VPPs. Algorithms for co-optimizing DER value to the grid and value to the DER owner are improving as experience and data accumulate.

2.iii. VPP participation in electricity markets

The range of ways in which VPPs monetize grid services is a function of several characteristics of U.S. electricity markets and regional variations.

Vertically integrated vs. restructured markets

The U.S. is geographically divided into *vertically integrated* markets and *restructured* markets. VPPs currently operate in both in different ways.

- *Vertically integrated markets*: Utilities can own and operate generation, transmission, and distribution assets.
- *Restructured markets* (also referred to as ‘deregulated markets’): Retail electricity suppliers (which include investor-owned utilities, municipal utilities, co-ops, and community choice aggregators and are referred to as ‘utilities’ in this report for simplicity) purchase power through wholesale markets or contractual arrangements rather than generate power with their own assets. Most utilities in restructured markets and some utilities in integrated markets belong to a nonprofit corporation called an Independent System Operator (ISO) or Regional Transmission Operator (RTO) that operates a regional bulk power system that balances demand with supply through a wholesale power marketplace.
- States voluntarily allow their utilities to join ISOs/RTOs that are regulated by the Federal Electricity Reliability Corporation (FERC), while the state Public Utility Commissions or Public Service Commissions (PUCs/PSCs) regulate the distribution systems.

²³ Outside of peak periods, VPPs can also contribute to baseload demand reduction. For example, a VPP deployment that spurs incremental energy-efficient DER adoption can reduce total electricity consumption (for example, by inducing consumers to replace resistive heating with a VPP-enabled heat pump thanks to VPP incentive payments).

U.S. Electricity market overview

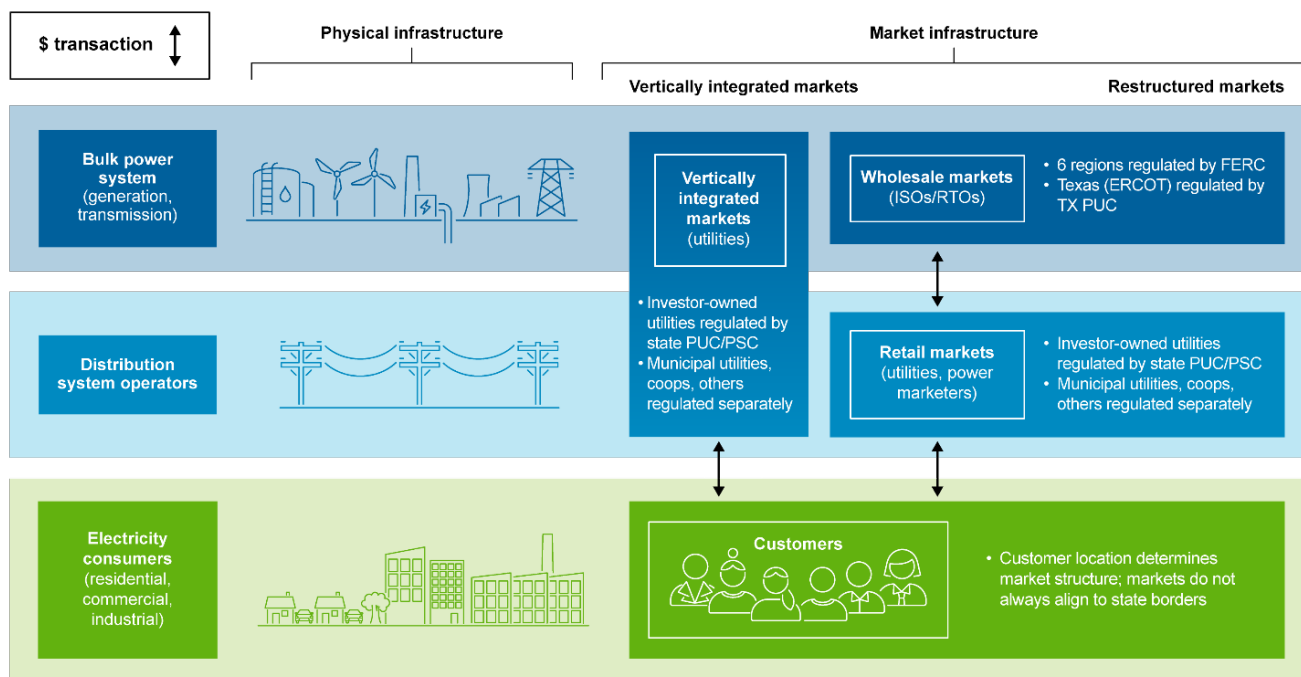

Wholesale market participation vs. retail market participation

In restructured markets, VPPs can participate in wholesale markets, retail markets, or both:

- **Wholesale:** Each ISO/RTO operates its wholesale market with its own structures (e.g., energy auctions) and rules, subject to regulatory frameworks established by FERC.^{24,lvii} ISOs/RTOs are responsible for ensuring adequate resources (e.g., generation, transmission) for their region. In September 2020, FERC approved Order 2222, which required the six FERC-jurisdictional ISOs/RTOs to allow participation of VPPs (referred to in the Order as "DER Aggregations"²⁵) in wholesale markets.²⁶ Implementation is ongoing across regions. As of August 2023, two out of six FERC-jurisdictional ISOs/RTOs allowed participation from VPPs that inject electricity for at least a subset of grid services, and Texas also began opening wholesale market ERCOT to VPPs. All ISOs/RTOs allow participation from VPPs that manage demand without injection. VPPs that bid into wholesale markets are referred to as 'market participant' VPPs.^{lviii}
- **Retail:** As an alternative to bidding into wholesale markets, VPP companies can contract with utilities in bilateral arrangements, or the VPP may be operated by the utility itself. Utilities use VPPs (either a third party or in-house) for a broad range of use-cases, including as an alternative to procuring energy or capacity from wholesale markets, to alleviate overloaded distribution systems, to build resilience for their customers, to avoid renewables curtailment, and more.²⁷ In all states, PUCs or PSCs regulate most utility planning, operations, and retail compensation as relates to VPP deployment. Municipal utilities, co-ops, and community choice aggregators (CCAs) are regulated by separate entities. VPPs operated at the retail level are often referred to as 'retail VPPs.'^{lix}

24 For reference: Participation of demand response resources – the most common form of VPP – in RTOs/ISOs in 2021 was 6.6% of peak demand on average across RTOs/ISOs; MISO had highest participation with 10.2% of peak demand served by DR; SPP was lowest with 0.3%.

25 See appendix for FERC definition of DER and DER Aggregator.

26 Order 2222 requires that all ISOs/RTOs will need to establish DERs as a category of market participant in wholesale markets, including energy, capacity, and ancillary service markets. FERC does not have governing authority over Texas-based ERCOT (Electric Reliability Council of Texas), which does not regularly conduct interstate wholesale electricity sales—nor over the ISOs operating in Canada. However, these ISOs generally utilize the standards and practices of other ISOs/RTOs.

27 In some instances, utilities may sell grid services from their own VPPs into wholesale marketplaces.

In early 2023, approximately 60% of VPP company revenue came from investor-owned utilities, 15% from wholesale markets, and the remaining 25% from municipal utilities, co-ops, and community choice aggregators.^{ix}

VPP market participation models

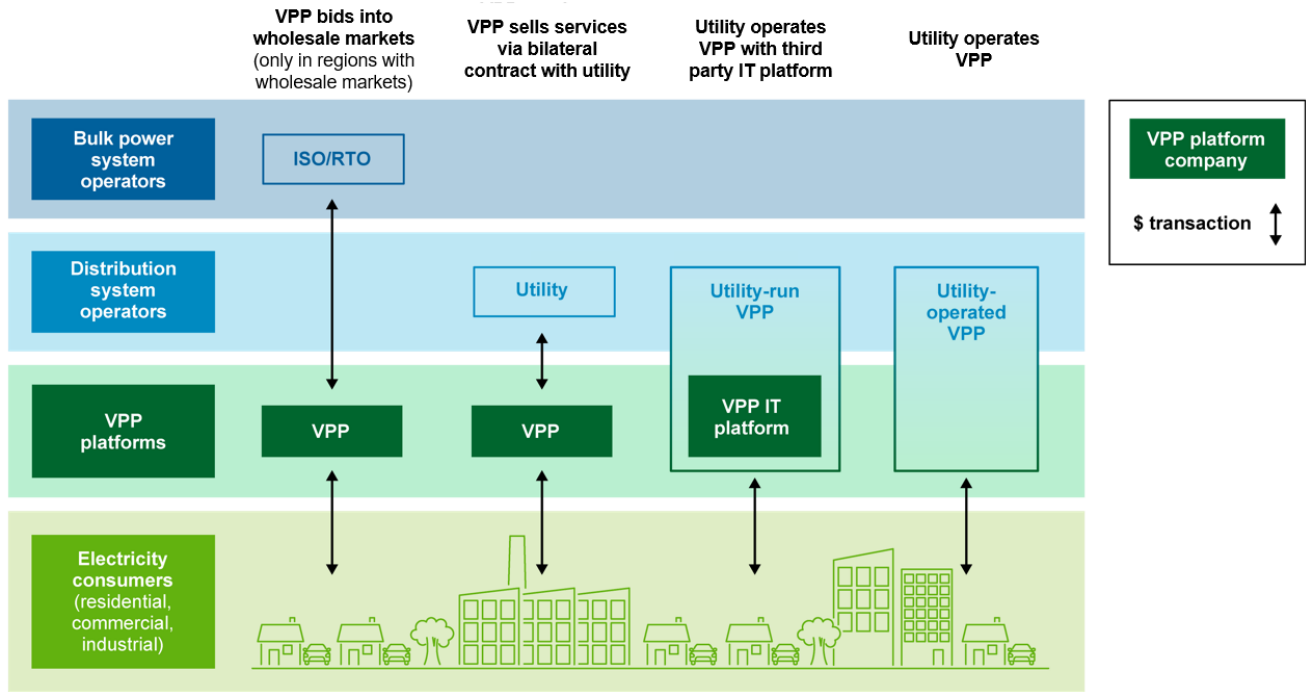

2.iv. VPP deployment by state

Third-party VPPs are concentrated in states with favorable policy and regulatory mechanisms that enable VPPs to sell to utilities in retail markets and/or participate in wholesale markets. Some mechanisms act to de-risk revenue streams for VPP services, for example by establishing marketplaces to buy and sell flexible demand services, or by accounting for the value of distribution investment deferral in utility planning proposals and cost-benefit assessments.²⁸ Other mechanisms increase the scale potential of VPPs, for example by subsidizing or mandating DER adoption. The various mechanisms reflect state- or municipality-specific priorities and regulatory frameworks.

²⁸ See section 4.iv. for detail on integrating VPPs into utility regulatory frameworks.

Number of third party VPPs procured by utilities in each state (2022)

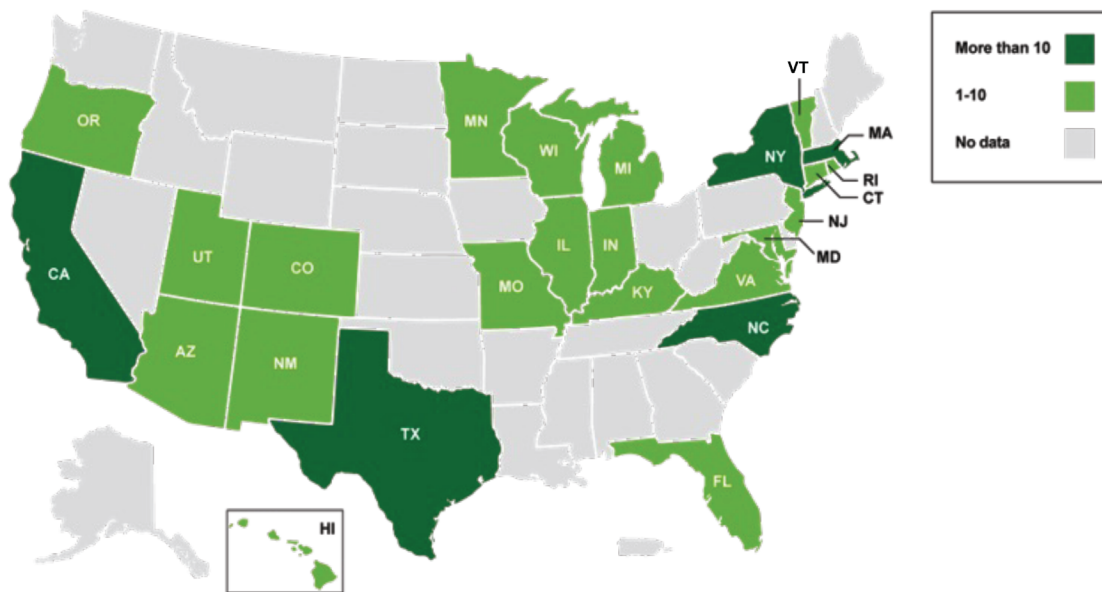

Note: One VPP operating across states is counted multiple times (once for each state)
 Source: Wood Mackenzie Grid Edge Services

Examples of policy and regulatory mechanisms favorable to VPPs in California, New York, Texas

California / CAISO^{lxi}

- **Demand Response Auction Mechanism:** A marketplace for VPPs to sell demand response to utilities.
- **Emergency Load Reduction Program:** Customer program that pays electricity consumers for reducing consumption during periods of electrical grid emergencies.
- **Self-Generation Incentive Program:** Rebates for installing energy storage systems.
- **Distribution investment deferral framework:** Mechanism to identify, review and select opportunities for existing or new BTM systems to alleviate future grid stress.
- **California Independent System Operator (CAISO)** allows full participation by VPPs in wholesale markets.

Texas / ERCOT^{lxii}

- ▶ ERCOT's **Emergency Response Service** program procures capacity from distributed resources and loads.
- ▶ **Aggregated Load Resource** provisions of ERCOT's protocols are expanding to include a new asset class of **Aggregated Distributed Energy Resources** (i.e., VPPs).
- ▶ **Commercial Load Management** programs, run by Texas utilities, compensate aggregations or individual loads for providing demand response.
- ▶ ERCOT **settles energy costs at the meter**, which means retail utilities pay ERCOT for consumed power as measured by smart meters, the price of which varies every 15 minutes based on supply and demand. This creates a financial incentive for retail energy providers to reduce peak-time consumption of their customers.

New York / NYISO^{lxiii}

- ▶ **Utility (retail-level) demand response programs allow dual participation** with NYISO (wholesale-level) demand response programs; e.g.,
 - ▶ Commercial System Relief Program
 - ▶ Distribution Load Relief Program
- ▶ New York ISO has multiple load reduction programs that incorporate qualified behind-the-meter DER aggregations; e.g.,
 - ▶ Special Case Resources program
 - ▶ Demand-Side Ancillary Services Program
- ▶ **Value of Distributed Energy Resources** is a retail electricity pricing scheme (called a tariff) that pays for electricity injection from DERs and accounts for multiple sources of value, including environmental benefits and avoided distribution system costs.
- ▶ **Non-wires alternatives** requirements mandate utilities must solicit bids from eligible DER solutions for all load growth-driven grid upgrades.²⁹

2.v. VPP business model economics

VPPs are economically viable today in states and regions where VPPs can sell to utilities or participate in wholesale markets and earn market prices. The scale of the grid services a VPP can provide (e.g., energy, capacity, and ancillary services) is a function of the volume of DERs enrolled, the flexible or dispatchable capacity that each DER provides, and how often the VPP can reliably call on the DERs. For example, one smart thermostat typically represents approximately one kilowatt of flexible electric heating or cooling demand that a VPP can reduce on a cold or hot day for about two hours (or ~2 kWh total), typically after pre-cooling/heating a house during off-peak hours or by staggering shorter time increment reductions to maintain participant comfort.

²⁹ In New York, non-wires alternatives (NWA) solicitations outline the location, hours, and quantity of load relief required. Utilities earn a portion (typically 20-30%) of the net benefits of the NWA if an award is made.

2.v.a. VPP operator economics

While the specific economics of a VPP operator will vary based on its DER composition, operational model, market participation model, and the needs and value creation opportunities of the local grid, VPPs have the following common cost and revenue drivers:

➤ Cost:

- ▶ **Project implementation and administration costs:** DER management system (DERMS) and associated IT and personnel costs; ongoing administrative costs.
- ▶ **Participant acquisition costs:** Marketing, consumer education, recruitment; potential DER subsidies; potential DER software integration fees paid to DER manufacturers.
- ▶ **Participant incentives:** One-time, periodic, or per-kWh payments to participants.

➤ Revenue:

- ▶ **Energy:** Payment per MWh delivered (e.g., avoided, shifted, exported), measured using contractually agreed-upon measurement and verification protocols that vary by DER type.
- ▶ **Capacity:** Payment per MW of energy option procured. (*Capacity product specifications vary by market and/or off-taker.*³⁰)
- ▶ **Ancillary services:**^{31xiv} Payment for services such as frequency regulation, ramping, etc.
- ▶ **Avoided costs:** Payment proportional to avoided costs such as deferred infrastructure upgrades (*Compensation varies by market.*³²)
- ▶ **Additional benefits:** VPPs today are rarely compensated for additional benefits they may offer, such as grid resilience or reduced emissions.

Across VPPs generally, the primary operational costs are participant incentives; in other words, most of the money spent on VPPs flows to electricity consumers (households and businesses). The primary revenue streams are energy or capacity payments, which vary by market. A range of prices for these services is shown in the examples below to reflect realistic variations across geographies and time periods that determine the overall financial viability of the VPP business model. The following three examples, all based on real VPP deployments in the U.S. today, help illustrate fundamental cost and revenue drivers from the perspective of VPP operators:³³

1. **Smart thermostat demand response VPP;**
2. **Utility-integrated BTM battery VPP;** and
3. **Emergency BTM battery demand response VPP.**

2.v.b. Example: Smart thermostat demand response VPP

This example VPP can be characterized as a retail VPP made up of 100,000 residential smart thermostats that collectively represent 100 MW of flexible demand capacity available during seasonal peaks. The VPP operator sells the capacity to a utility, for example as an alternative to the utility procuring peaker plant generation capacity from a wholesale marketplace.

30 For example, capacity can be procured in the form of energy efficiency programs that decrease demand on an ongoing basis or can be procured in the form of demand response programs that are called during specific events. Each program type has its own performance requirements that vary by jurisdiction.

31 Historically, the market value of ancillary services has been <5% of total wholesale electricity market value.

32 In some markets, utilities are encouraged to use (and compensated for using) strategies that help defer or eliminate the need to upgrade a transmission or distribution system while satisfying goals of managing costs, ensuring reliability, or other policy objectives. Such strategies include, but are not limited to, the use of VPPs.

33 Potential costs incurred by the utility to enable procurement of services from a VPP are not included in the example VPPs' costs.

Illustrative operations | Smart thermostat demand response VPP

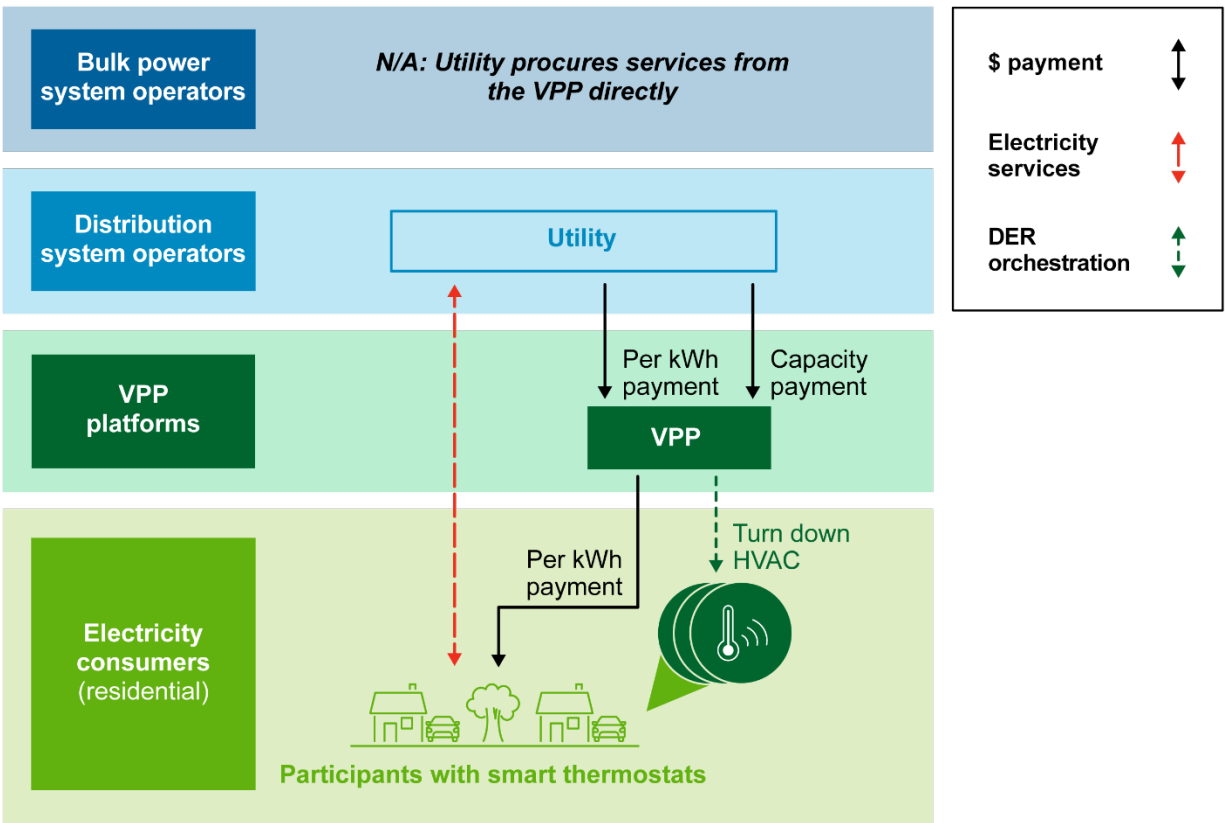

Costs: In this example, the VPP operator subsidizes the cost of the smart thermostat and installation for participants, pays annual IT integration fees to connect the VPP’s DERMS platform to the smart thermostat software, and offers customers \$1.50 per kWh for turning down their electric AC or heating for approximately two hours (may be staggered in shorter time increments over a longer window) during peak events (20 per year^{34(xv)}) averaging \$60 per participant per year.

Revenue: VPP revenue is generated primarily by selling its 100 MW of flexible capacity at \$80-100 per kW-yr as a future energy option to utilities to call during peak demand events. This VPP earns a small amount of additional revenue from the utility for actual energy delivered.

Margin for VPP operator: In this model, the VPP economics are roughly break-even after five years. See appendix for detailed cost and revenue inputs and calculations.

34 For reference, in summer 2022, CAISO issued 11 ‘Flex Alerts’ calling for energy conservation during critical peak hours when demand for power was at risk of exceeding supply.

Annual cost and revenue of illustrative smart thermostat demand response VPP of 100 MW, \$M

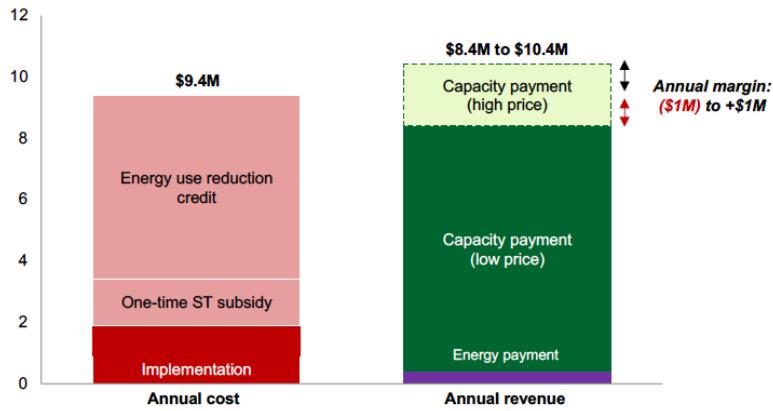

Costs		Revenues		
Participant incentives	Energy credit	\$1.50 per kWh	Capacity	\$80 to \$100 per kW-year
	Smart thermostat subsidy	\$75 per device (one-time)		Energy
VPP operations	Marketing & recruitment	\$50 per participant		
	Implementation	\$1M one-time & \$700K per year		

Note: Implementation, marketing cost, and one-time smart thermostat subsidy are annualized over 5 years.
 Source: Industry interviews

Participant perspective: In this VPP, participants get smart thermostats for free or for a highly subsidized price. For participating in a two-hour event, the participant receives \$3-6 of incentive payments, typically paid out quarterly. Participation will not result in significant changes to indoor temperatures if heating and cooling demand reductions are appropriately staggered by the VPP across the large number of homes and buildings, and if those homes and buildings are properly insulated (which is a challenge in some communities, as discussed in subsequent chapters).

2.v.c. Example: Utility-integrated battery VPP

This example VPP can be characterized as a retail VPP made up of 7500 BTM batteries that collectively represent 20 MW of capacity used for both demand shaping and export. The utility pays the VPP for three services: capacity reduction during peak demand (i.e., the option to *export* energy from the battery for local use between 7-9pm); capacity build during peak solar supply (i.e., the option to *charge* batteries between 10am-2pm); and fast frequency response (an ancillary service). The VPP is operated by a VPP platform company in partnership with a retail utility.

Illustrative operations | Utility-integrated battery VPP

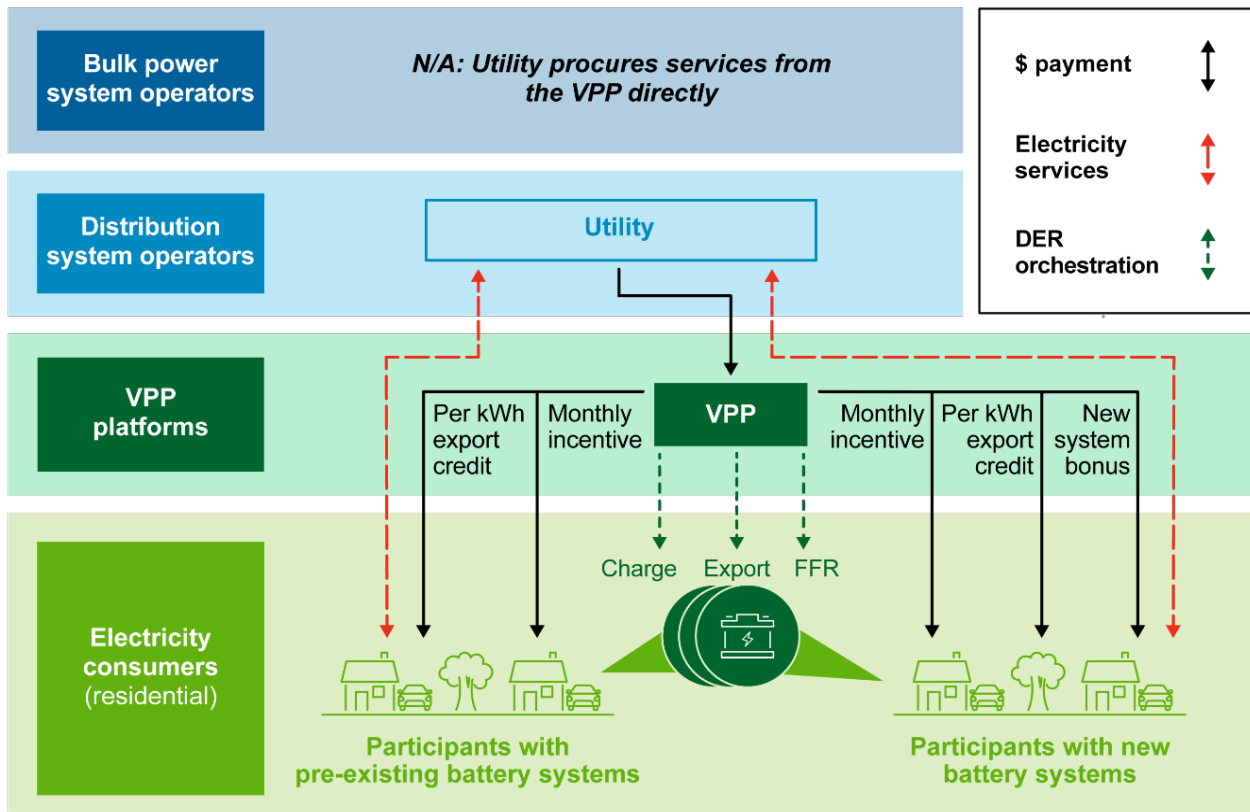

Costs: The VPP company bears the administrative and IT costs of implementation; IT costs include both fixed start-up costs and a monthly software integration fee paid to the battery manufacturers. The VPP operator largely avoids local marketing costs by partnering with local battery installers who advertise participation opportunities; in return, installers benefit from increased battery sales and installation revenue. There are three incentives paid to participants: Up-front payment of \$1000 per kW of battery capacity for customers buying new systems, monthly flat payments of approximately \$16 for participation based on capacity enrolled, and a \$0.20 credit per kWh exported.

Revenue: The utility pays the VPP capacity payments for each service: capacity reduction, capacity build, and fast frequency response (FFR). Prices for this capacity range from \$80-375 per kW-yr.

Margin for VPP operator: This VPP's margin is highly dependent on the negotiated prices for the three services, which vary by market, by utility, and by contract. In combination, they typically offset VPP costs with a modest margin.

Annual cost and revenue of illustrative Utility-integrated BTM battery VPP of 20 MW, \$M

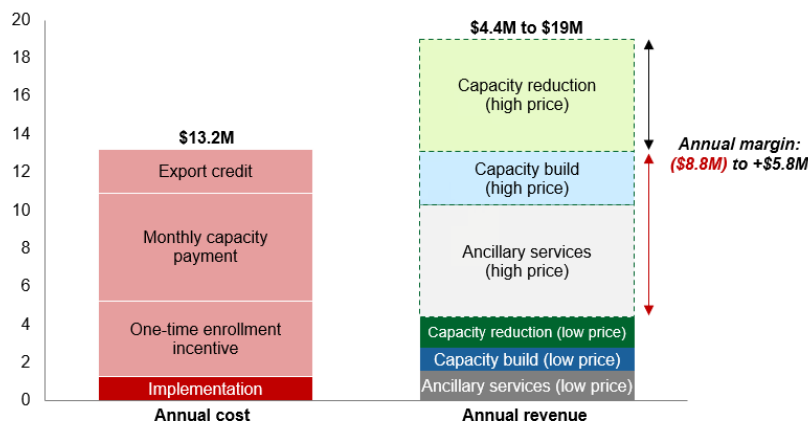

Costs

Category	Component	Value
Participant incentives	Energy export credit	\$0.20 per kWh ~4 hr per event; 144 events
	Battery capacity payment	\$15.75 per kW-month
	Enrollment incentive	\$1000 per kW (one-time)
VPP operations	Implementation	\$450K per year & \$9 per battery-month

Revenues

Category	Component	Value
Capacity reduction	Lo	\$80 to 375 per kW-year 7-9pm battery dispatch
	Hi	
Capacity build	Lo	\$60 to 200 per kW-year 10am-2pm charging
	Hi	
Ancillary services	Lo	\$80 to 375 per kW-year Fast frequency response
	Hi	

Note: One-time implementation costs and enrollment incentives for new batteries are annualized over five years.
Source: Industry interviews.

Participant perspective: In this VPP, the prospect of one-time and ongoing payments significantly influences a consumer’s decision to purchase a new battery. The \$9,000-12,000 up-front cost of one battery (5-20 kWh of nameplate storage capacity each) with installation is partially offset by a \$4,000 new system payment (for a system with 4 kW of flexible capacity) and \$200 or more annually. The VPP operator preserves enough charge in the battery to always provide backup power to the participant in the case of a grid outage.

2.v.d. Example: Emergency BTM battery demand response VPP

This example VPP can be characterized as a market participant VPP made up of 10,000 BTM batteries that collectively represent 35 MW of capacity (or about 100 MWh of stored energy) that is used for demand reduction during critical peak events. Many batteries may be paired with distributed solar arrays, but it is not required for participation. The VPP operator is the battery manufacturer/seller that, after selling the battery, asks customers to opt in to paid battery dispatch only when prices in wholesale markets are high. The VPP notifies opted-in battery owners in advance of earning opportunities, and battery owners can participate on an event-by-event basis.

When dispatched from the batteries, the energy serves the home’s/building’s consumption needs and is not injected back to the grid. Coordinated dispatch of batteries to serve on-site demand during peak has the desired effect of reducing the demand on the bulk power system. Keeping the energy behind the meter in this way may be required by the local utility upon battery installation and interconnection (a condition that is then programmed into the battery settings) or may be a performance requirement of the specific wholesale market program in which the VPP participates.

Illustrative operations | Emergency BTM battery demand response VPP

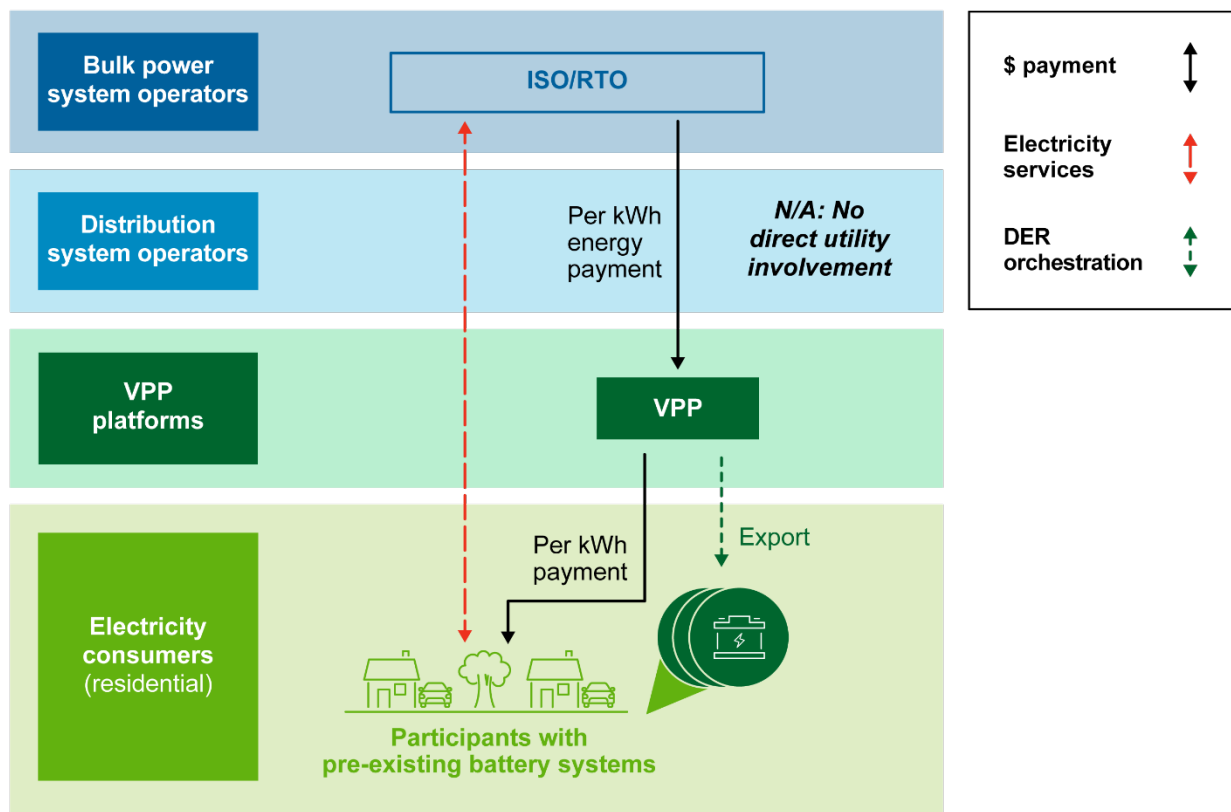

Costs: Implementation and participant acquisition costs are low given the VPP operator's (i.e., the battery manufacturer's) existing access to the battery software, customer relationship, and ongoing interactions via smartphone app. The VPP operator does not offer any battery rebate or sign-up bonus. It does offer \$1.50 per kWh to participants to dispatch stored energy during high-demand periods.

Revenue: The VPP only calls an event when wholesale energy prices rise sufficiently high in short-term energy markets. The VPP bids at a price that clears its cost to aggregate and compensate participants; the VPP does not sell its capacity in forward markets (i.e., does not commit in advance to dispatch).

Margin for VPP operator: In this example VPP, the economics are highly dependent on the frequency of peak events (estimated at 15 events per year) and market-clearing energy prices during those peaks. By bidding into energy markets with prices above \$1500 per MWh (\$1.50 per kWh) during peak events,³⁵ the VPP will earn a margin when paying customers \$1.50 per kWh given very low fixed costs.

³⁵ For reference, electricity prices in ERCOT rose to \$9000 per MWh during storm Uri when many conventional power plants failed due to extreme weather, resulting in supply shortages; ERCOT subsequently capped prices at \$5000 per MWh.

Annual cost and revenue of illustrative emergency BTM battery demand response VPP of 35 MW, \$M

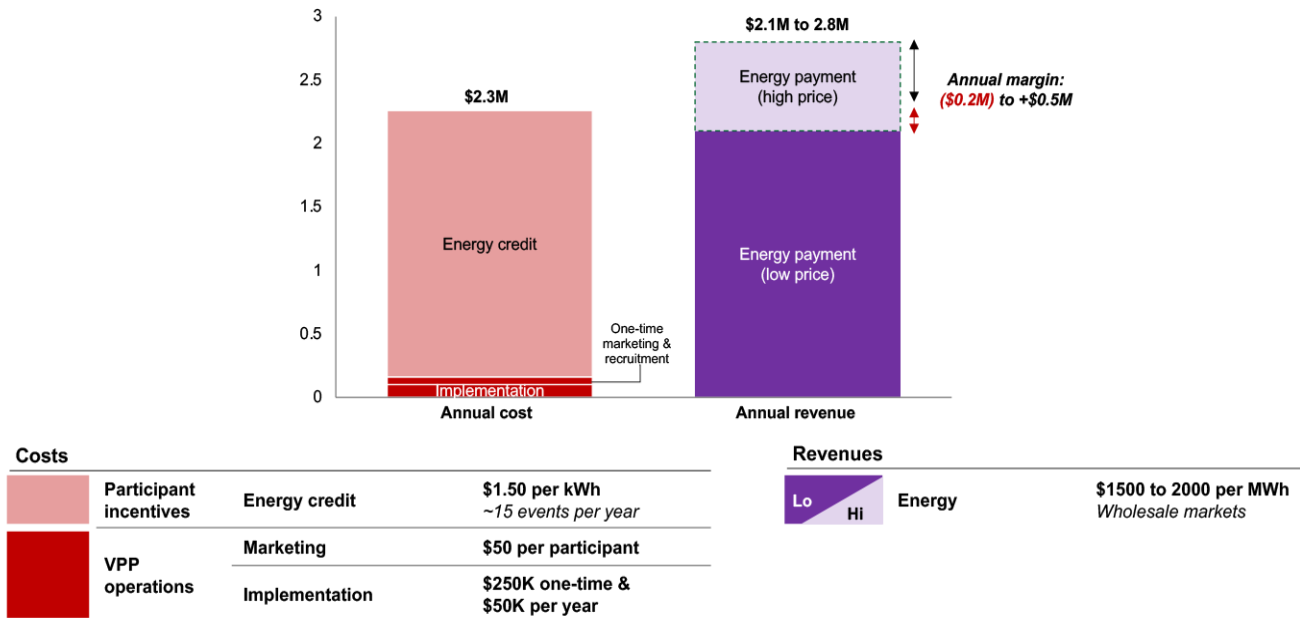

Note: This VPP does not earn revenue from capacity sales, ancillary services, or other benefits such as grid reliability and emissions reduction. Implementation and participation costs are annualized over five years.
Source: Industry interviews.

Participant perspective: Participants have purchased the battery systems for their personal backup power at a cost of roughly \$9,000-12,000, including installation. The VPP preserves enough charge in customer batteries to provide backup power to the participant if needed, according to thresholds customized by the participant (often 20% charge or higher). Participant incentives of ~\$20 per event (~\$2 per kWh for 10 kWh) are small in comparison to the DER investment and are not a significant driver of battery adoption for these participants who view VPP participation as an added benefit of ownership.

2.v.e. Additional VPP examples: Solar-plus-storage, Water heaters, Managed EV charging, V2X, C&I Loads

VPPs that aggregate and orchestrate other types of DERs share the fundamental cost and revenue drivers of battery VPPs (storage with or without generation) and smart thermostat VPPs (flexible demand). Solar-plus-storage VPPs operate similarly to battery-only VPPs, with the advantage of charging the batteries from on-site, no-marginal-cost, renewable energy rather than from the grid. For example, VPP platform Sunrun bid into New England wholesale markets in 2019 with 20 MW of capacity from home solar and battery systems and delivered 1.8 GWh in the summer of 2022.^{lxvii} Water heater VPPs operate similarly to smart thermostat VPPs, but with less seasonality. A study conducted by grid operators and utilities in the Northwest U.S. showed that switching from uncontrolled electric resistance water heaters to managed heat pump water heaters can reduce 90% of evening peak load.^{lxviii}

Managed charging for EVs shifts large and flexible charging demand, taking into account participant driving and charging patterns when modeling available capacity and managing energy use (i.e., accounting for the timing of when the car is plugged in and amount of charge needed). For example, retail electricity provider Octopus Energy offers Texas customers a discount on their electricity rate (price per kWh) in return for managing their overnight EV charge timing (with override available),^{lxix} this keeps participation simple for the consumer while optimizing EV charging for the grid.

Use-cases for VPPs that dispatch energy from EV batteries back to a building or back to the grid (V2X) are concentrated in commercial fleets today. Some commercial fleets – for example, school buses that are parked for much of the day — have predictable driving and charging patterns that increase certainty over when and how vehicles can provide grid services. Revenue from grid services can help offset the incremental cost of fleet electrification and bidirectional chargers, which can be up to several thousand dollars more per charger than unidirectional chargers of similar capacity. In an example of a small commercial V2X deployment, FirstLight Power, Fermata Energy, and Skyview Ventures installed two Fermata 15 kW bidirectional charging stations for the FirstLight operations team EVs (Nissan LEAFs) in Massachusetts.^{lxx} In the residential setting, Ford’s Home Integration package for the Ford F150 Lightning enables vehicle-to-home dispatch as a backup power source. While the physical technology for vehicle-to-grid dispatch is available for residential use, the operations and customer experience are still being tested at pilot scale in the U.S. – for example, in Duke Energy’s collaboration with Ford in North Carolina.^{lxxi}

The economics of C&I demand flexibility vary by type of load and the opportunity cost of reducing electricity consumption. While flexible demand capacity from C&I loads is not growing as fast as residential DER capacity, it may make up nearly half of cost-effective demand flexibility available by 2030.³⁶

2.vi. An inflection point for VPPs

A confluence of market factors put VPP growth at a potential inflection point. Utilities must reliably and affordably serve rising electricity demand that is in part driven by unprecedented growth in DER adoption. At the same time, the flexibility of this demand – the ability to better time-match demand to supply – is increasing thanks to DERs’ flexible demand, generation, and storage capacity. The rapid pace of DER adoption expands the potential scale of any given VPP investment. Devices are increasingly connected via Bluetooth, Wi-Fi, and cellular networks. VPP platforms are innovating to improve participant experiences with software that digests consumer energy data and optimizes DER controls around their preferences. DER technology advancements are expanding the range of grid services performed. Distribution grids are gradually digitizing in ways that can better integrate DERs and their potential grid services.

Rather than viewing the massive adoption of EVs and other DERs just as load to serve, utilities and regional grid operators can view this as an opportunity to increase the flexibility of the grid and more efficiently use existing resources and infrastructure. The following chapter discusses the value at stake.

³⁶ See appendix for detail on 2030 cost effective flexible demand capacity and savings potential as estimated by The Brattle Group (2023).

Chapter Three: Pathway to VPP Liftoff

Key takeaways

- ▶ Deploying 80-160 GW of VPPs—tripling current scale—by 2030 can expand the U.S. grid’s capacity to reliably support rapid electrification while redirecting grid spending from peaker plants to participants and reducing overall grid costs. At this scale, VPPs would address 10-20% of peak demand.
- ▶ Liftoff will involve progress on five imperatives:
 1. Expand DER adoption with equitable benefits
 2. Simplify VPP enrollment
 3. Increase standardization in VPP operations (*this will accelerate imperative 4 & 5*)
 4. Integrate into utility planning and incentives
 5. Integrate into wholesale markets
- ▶ As a parallel path to the scaling-up of VPPs in the market today, investment should continue in next-generation VPP hardware, software, and business model innovation.
- ▶ Properly designed, implemented, and regulated, VPPs can advance energy and environmental justice by retaining and creating good energy jobs, increasing affordability and reliability of electricity for underserved communities, and reducing air pollution created by traditional peaker plants.

3.i. VPP potential in 2030

With expected patterns of DER adoption, the national capacity of peak-coincident flexible demand that can be cost-effectively managed will grow to 180 GW by 2030 (22.5% of peak), according to new analysis from The Brattle Group. **Managing all available flexible demand represents potential savings of nearly \$13B per year.** These benefits come from managing flexible demand DERs through mechanisms such as smart thermostat demand response, commercial demand response, and time-varying rates that reshape load curves. Estimated savings from lower peaks would accrue from deferred capital expenditure for generation (\$8.8B), transmission (\$1.3B) and distribution (\$1.4B) infrastructure, in addition to avoided energy costs (\$0.9B) and ancillary services costs (\$0.4B).³⁷ Additional capacity and associated savings from expected storage and generation DERs is not included in these estimates.

With optimal (rather than expected) deployment and siting of demand, generation, and storage DERs, potential savings could grow to \$22B per year in 2030, according to scenarios modeled by Clack et al.^{lxxii} Optimal deployment in this scenario implies a cumulative 315 GW of peak-coincident DER capacity but should be considered theoretical given the important role of consumer choice in DER adoption and location (i.e., utilities can support, but do not control, DER adoption).

³⁷ See appendix X for detail on 2030 cost effective flexible demand capacity and savings potential as estimated by The Brattle Group (2023).

Estimates of peak-coincident DER capacity and associated 2030 system savings

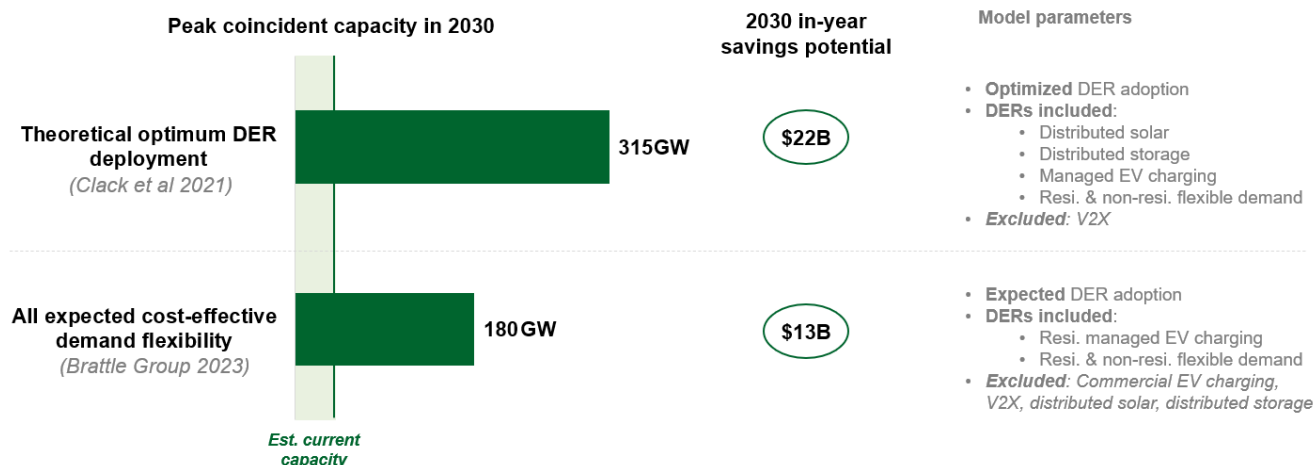

Note: Additional studies that model DER capacity potential based on pre-IRA DER adoption expectations are not shown because they underestimate growth vs. current expectations; this includes projections of 62 GW of peak-coincident capacity in 2030 published by RMI (2023) and 200 GW of peak-coincident capacity in 2050 published by NREL (Electrification Futures Study, 2021).

Source: The Brattle Group analysis 2023; Clack et al. 2021, *A Plan for Economy-Wide Decarbonization of the United States*.

3.ii. Pathway to VPP liftoff

Deploying 80-160 GW of VPPs—tripling current scale—by 2030 could expand the U.S. grid’s capacity to reliably support rapid electrification while redirecting grid spending from peaker plants to participants and reducing overall grid costs.³⁸ In the last decade, the U.S. invested \$100B of capital to build 94 GW of gas assets, over 20% of which was from peaker plants.^{lxixiii} By 2030, the U.S. grid will need to add resources that can serve approximately 200 GW of demand during peaks. At the same time, hundreds of gigawatts of flexible DER capacity will be available for VPPs to aggregate and orchestrate into dispatchable resources that redirect most spending back to participants. Harnessing 80-160 GW of capacity (10-20% of 2030 peak) with low-cost VPP models can avoid over \$10B per year in grid spending that translates to energy savings for all Americans, whether or not participating in a VPP.³⁹

Beyond financial impacts, VPPs have the potential to reduce the risk of outages caused by capacity shortfalls, increase the efficiency of existing and new grid infrastructure, support rapid decarbonization, deliver health benefits from improved air quality, and empower communities.

Intentional design and deployment of VPPs will be critical to ensure these benefits target the communities that need them most. Liftoff for VPPs will be achieved when utilities, regional grid operators, and their regulators account for the potential value of VPPs and integrate VPPs into core grid planning and operations.⁴⁰

38 Capacity potential of 80-160 GW is based on 10-20% of estimated peak load in 2030, taking into account estimated current capacity, estimated available cost-effective demand (180 GW), projected increases in generation and storage DER capacity, and the challenges and potential solutions for VPP liftoff discussed in Chapter 4.

39 Potential savings associated with for 80 GW (\$6B) to 160 GW (\$11B) of VPP capacity are estimates based on the savings-per-GW ratios of The Brattle Group (2023) and Clack et al. (2021) analysis of peak-coincident DER capacity (est. \$0.07B per GW in both studies), recognizing savings may not accrue linearly. The functionality of VPPs for the grid goes beyond reducing peaks. DERs that offer energy efficiency can reduce baseload energy demand, and flexible demand DERs can follow supply to enhance the utilization of traditional clean energy assets as they come online. Potential VPP functionality and value will vary based on DER availability, mix of renewable energy supply, and infrastructure constraints.

40 VPPs are a critical tool in asset portfolios that will likely include long-duration energy storage to help balance supply and demand with a high mix of renewables, and clean, firm resources such as nuclear and geothermal to increase baseload supply.

VPP liftoff

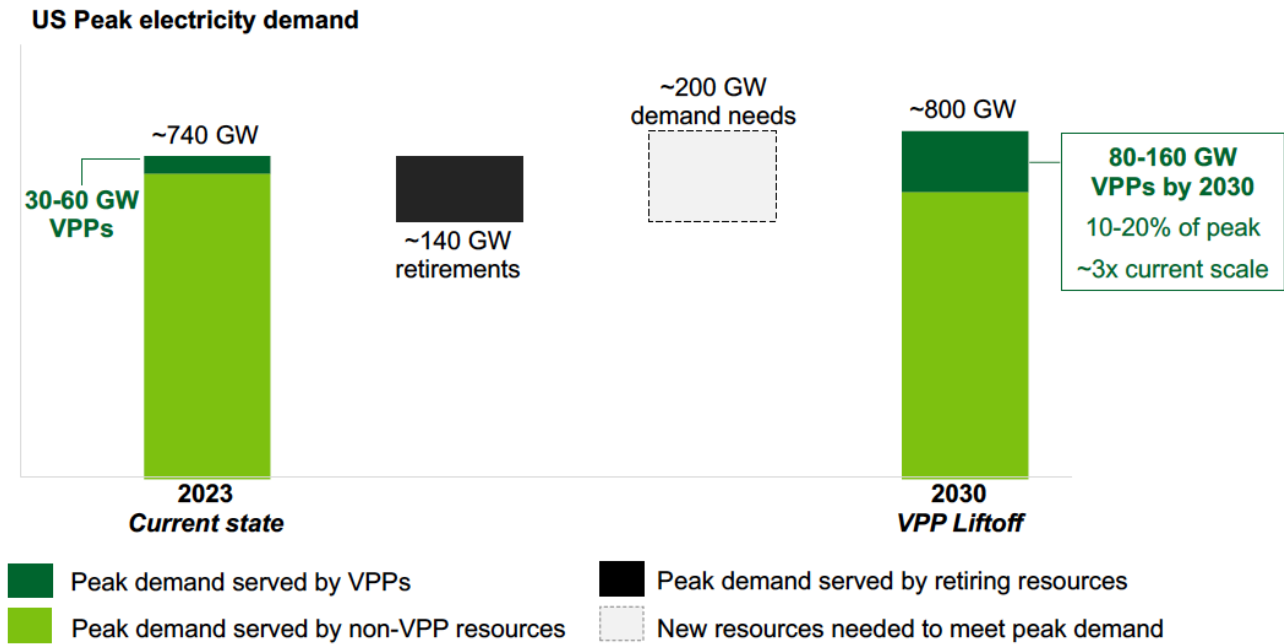

Notes: Peak demand in the U.S. is expected to grow approximately 8% in the U.S. by 2030 – from 743 GW to 802 GW, or 59 GW (estimated by The Brattle Group based on total electricity consumption projections from Office of Policy National Energy Modeling System mid-case electrification scenario). It is estimated 162 GW to 183 GW of generation will be retired between 2023-2030. If retiring assets were operating at full capacity, this would imply a supply gap of 221 to 242 GW. However, the majority of recent and expected retirements are aging coal plants, with some oil and natural gas plants retiring as well; retiring assets will likely be operating below full capacity. For this reason, the supply need is estimated conservatively to be ~200 GW (~60 GW new peak demand + ~140 GW peak demand no longer served by assets retired). 2023 VPP capacity based on market estimates from Wood Mackenzie (2023) and FERC (2021). 2030 VPP capacity potential and savings potential based on industry interviews and analysis by The Brattle Group (2023) and Clack et al. (2021).

The pathway to liftoff for VPPs will involve progress on five imperatives.

Imperatives for VPP Liftoff

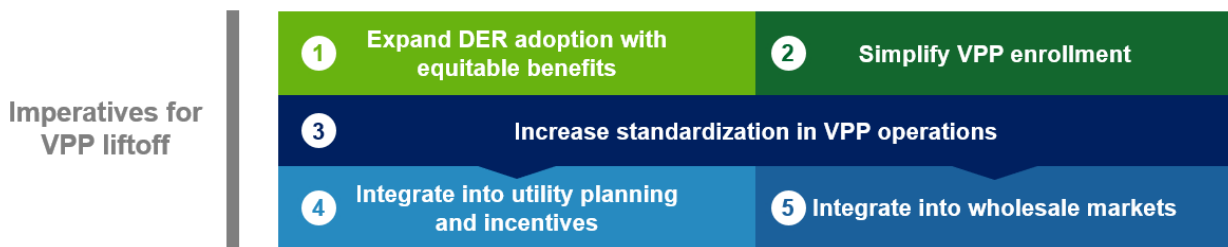

Expand DER adoption with equitable benefits: Scaling VPPs rapidly relies on accelerating DER adoption, and scaling VPPs equitably relies on prioritizing benefits for disadvantaged communities. The affordability and accessibility of DERs is critical to create equitable access to VPP participation; by prioritizing support for those facing the highest energy burdens, energy cost savings can be targeted at communities most in need. Beyond monetary savings, intentional VPP deployment can offer disadvantaged communities increased grid reliability and resilience, good job opportunities, and better air quality.

6. **Simplify VPP enrollment:** Enrolling new DERs to build the capacity of VPPs will involve greater awareness and streamlined enrollment among DER owners and purchasers. Clearing enrollment hurdles with measures such as automatic enrollment with opt-out and interoperability of DER software will help scale VPPs as record volumes of new DERs come online.
7. **Increase standardization in VPP operations:** In order to replicate successful VPP deployments across jurisdictions quickly, the industry will need progress from bespoke VPP approaches to a narrower set of standards that are trusted by utilities and regional grid operators. Alignment is particularly important in areas such as performance forecasting, measurement and verification, and service contracts. Standards for the operations of distribution systems writ large can inform and guide the development of VPP standards in areas such as system reliability requirements, DER interconnection, energy data sharing, product certification, and cybersecurity.

Increased standardization (*Imperative 3*) will accelerate VPP integration into retail and wholesale markets (*Imperatives 4 & 5*).

8. **Integrate into utility planning and incentives:** Retail utility and vertically integrated utility regulation – specifically the planning requirements and compensation structures that govern utilities – in many states will need to be revised to better align utilities’ incentives to system-optimal VPP deployment.
9. **Integrate into wholesale markets:** In restructured markets, the approval of FERC Order 2222 in September 2020 instructed RTOs/ISOs to allow participation of DER aggregations in wholesale power markets (*discussed in Chapter 2*). Between now and 2030, *when* and *how* RTOs/ISOs integrate VPPs into the planning and operations of bulk power systems will influence the growth of VPP platforms regionally.

As a parallel path to the scaling-up of VPPs in the market today, investment should continue in next-generation VPP and DER hardware, software, and business model innovation. While the focus of this liftoff report is on the 2030 opportunity for VPPs, achieving the full value of VPPs longer-term will involve new DER technologies (e.g., innovative microgrids^{41, lxxiv}), new ways of integrating DERs as grid resources (e.g., contributing >25% of peak), an expanded set of grid services from VPPs, and other important advancements.

3.iii. Broader implications

Capital formation

Americans are projected to invest approximately \$290-505 billion per year in EVs, and \$50-105 billion on other DERs per year, 2025 to 2030. These investments are largely expected to be made without regard for the DERs’ potential grid services value. However, the value of the DER to consumers increases with the opportunity to enroll in a VPP. Investors can support DER adoption and VPP value creation through a variety of DER financing mechanisms. Examples include asset-backed securities in residential solar projects, publicly traded equities in electrical equipment and EV manufacturing companies, venture capital and growth equity investments in EV charging infrastructure developers, manufacturing investments in grid-connected HVAC and water-heating equipment, and more.

Supporting investments in DERs among disadvantaged communities is a time-sensitive issue for multiple reasons. First, many households and businesses buy replacement appliances such as heating systems and water heaters every 10-20 years on an emergency basis when the appliance breaks. Low-credit score or low-income consumers may face high borrowing costs (e.g., credit card financing) when purchasing the replacement. Offering low-cost financing for DERs can induce buyers to choose the VPP-enabled

41 For example, Idaho National Laboratory has collaborated with private industry and government customers to develop self-contained microgrid systems ‘in-a-box’ that use energy sources such as solar panels, wind turbines, and even small nuclear reactors to ensure energy supply during emergency situations or in remote locations.

option for necessary (not incremental) purchases—an opportunity that may not arise again for decades. Additionally, the highest demand peaks on the grid will be the most lucrative for VPPs to address, and as VPP scale grows to manage down peaks, the incremental participant's capacity may have diminishing returns. Early enrollees will be positioned to reap the greatest potential rewards.

Beyond investments in DERs, investment in VPP platforms can be attractive to corporations and investors as a low-capex, IT-driven solution with a large and rapidly growing addressable market.

Financing support can accelerate deployment in many ways such as by building out and improving IT capabilities, acquiring customers, and posting capital reserves required to bid into wholesale markets.

Workforce implications

The availability of qualified electricians, electrical contractors, and other skilled trades talent is a prerequisite to installing and maintaining the DERs that power VPPs.

A grid managed with higher numbers of DERs is predicted to require significantly more full-time jobs in the energy sector than a grid that relies on utility-scale assets alone.^{42, lxxv} On an immediate basis, utilities' partnerships with the International Brotherhood of Electrical Workers (IBEW) and the National Electrical Contractors Association (NECA) in their area could facilitate DER adoption, such as by pre-qualifying contractors to install DERs to ensure the quality of work and that only necessary electrical system upgrades are completed. These organizations have the advantage of well-developed training programs that integrate certifications for new technologies and help a local workforce adapt to changes in market demand.^{lxxvi} In the long run, intentional efforts are needed to invest in and grow these professions. Special attention should be given to recruit and retain people from underrepresented demographic groups. For instance, in the case of electricians, women only comprised 2% of the total workforce as of 2021.^{lxxvii}

Training, pre-apprenticeship, and worker-serving community-based organizations can be important partners to improve access to good jobs in DERs and VPPs,

prepare and connect people to apprenticeship programs, and identify and address barriers people face to completing apprenticeship programs such as childcare costs and transportation access. The federal government is already taking measures to strengthen the electrician workforce, such as by tying state funding for EV charging to electrician training and certification.

Energy & environmental justice

Properly designed, implemented, and regulated, VPPs can advance energy and environmental justice by increasing affordability and reliability of electricity for disadvantaged communities and reducing pollution created by traditional peaker plants.

Two-thirds of peaker power plants in the U.S. are located near communities with a higher percentage of low-income households than national average, and nitrogen oxide emissions rates are higher for peakers located near these communities. Deployment of VPPs can help to reduce emissions from these plants and therefore improve air quality in these communities.^{lxxviii} Depending on dispatch scenarios, optimizing DER dispatch can also alleviate hosting capacity constraints. Research has found evidence that hosting capacity disparities can align with socioeconomic factors such as race and ethnicity.^{lxxix} Grid infrastructure limitations must be considered in the early stages of project development to avoid skewing deployment away from underserved communities.

Additional considerations, system upgrades, financial assistance, and community outreach may be required to support disadvantaged community participation in VPP and related programs.

For example, homes in disadvantaged communities tend to be older and less energy efficient, which heightens the need for efficiency and weatherization programs alongside programs promoting VPPs. The electrification of household energy services has the potential to improve indoor air quality but may require upgrades to local distribution systems, which could increase the average implementation cost of the program.

⁴² Modeling by Clack et al (2021) compares two national decarbonization scenarios (net zero by 2050): a scenario with only utility-scale assets vs. a scenario with optimally-sited DERs. The optimal DER scenario is associated with an estimated 304,000 additional full-time energy sector jobs by 2030.

VPP operators can balance cost and emissions considerations to advance decarbonization, energy and environmental justice, and financial goals. In the near-term, as some regional grids continue to rely on coal and other fossil fuels, VPPs that shift DERs electricity demand to low-cost hours without considering emissions and climate impact may risk increasing emissions if the cheaper hours are powered by high-carbon fuels such as coal.^{lxxx} Lifecycle emissions of DERs manufacturing and installation should also be taken into account.^{lxxxi}

The way in which financial savings and costs from VPP deployment are allocated across utility customers must be carefully considered in the context of distributive justice goals. Customers with high energy burdens can benefit from VPPs through direct participation incentives—for example, in water heating demand response programs—that lower or offset their energy bills. Energy savings achieved with VPPs that accrue to a utility may be distributed to customers in several additional ways, such as through lower electricity rates for all customers or through a first-loss funding pool to subsidize financing for new DERs. Returning grid savings only to participating DERs owners will not advance energy justice if DERs adoption is not equitable. For some utilities, grid upgrade costs will be incurred to deploy VPPs, including sensing, communication, computing, distributed intelligence, and control infrastructure. Investments in the smart grid system that are borne by all electricity consumers should, in turn, benefit all consumers.

In the development and promotion of new VPPs, the communities affected by, and benefiting from, these programs must have a voice in their design and execution. Procedural justice is one of the founding tenets of energy justice; it concerns who is part of the decision-making process, and whether everyone's voice is heard in a fair, transparent process. The development, promotion, and execution of a VPP must carefully consider this aspect of energy justice.

Chapter Four: Challenges to Liftoff and Potential Solutions

VPP liftoff will require collaboration across a diverse set of stakeholders to examine a wide range of solutions and take appropriate actions. The following summary of challenges to the five imperatives, potential solutions, and associated actions for consideration by public and private stakeholders is meant to initiate a dialogue; it is not a comprehensive inventory.

Priority potential solutions for VPP liftoff

Imperatives for liftoff	Potential solutions
1 Expand DER adoption with equitable benefits	a. Financial assistance for DER adoption b. Workforce development for DER installation & maintenance
2 Simplify VPP enrollment	c. Consumer education d. Automatic enrollment with opt-out e. VPP-enablement in DER manufacturing
3 Increase standardization in VPP operations	f. Common modeling tools and datasets for performance forecasting, management, and measurement g. Standardized service agreement contracts h. Industry- and regulator-aligned distribution system reliability standards and grid codes i. Narrowed set of DER interconnection and data standards j. Nationally-recognized cybersecurity measures
4 Integrate into utility planning and incentives	k. Comprehensive valuation of VPP benefits l. Integrated distribution system planning requirements for utilities m. Aligned incentives in utility compensation and rate design n. Proactive VPP planning and deployment among utilities
5 Integrate into wholesale markets	o. Support for ISOs/RTOs to overcome region-specific barriers to FERC Order 2222 implementation

4.i. Expand DER adoption with equitable benefits

Key takeaways

- Penetration of DERs is low nationally (e.g., <4% households have rooftop solar, <20% have smart thermostats). Low penetration of DERs will limit the opportunities a community has to deploy, and benefit from, VPPs at scale.
- Both the up-front cost and financing costs of DERs can be prohibitively expensive, and DERs face installation hurdles in some service areas.
- To make DERs more affordable for all Americans, public and private financial institutions, utilities, and other organizations could provide low-cost financing for DERs and help consumers access available rebates and tax incentives.
- Installation hurdles may be addressed through workforce development that prioritizes good jobs and (for applicable DERs) through permitting practices.
- The potential benefits of DERs and VPPs extend beyond DER owners and VPP participants, and include lower electricity bills, improved grid reliability and resilience, job opportunities, and improved air quality for the broader community. Equitable benefits are critical for VPP liftoff.

Challenges

Challenge: Penetration of DERs is low nationally and both the up-front cost and financing costs of DERs can be prohibitively expensive.

For example, heat pump water heaters currently account for 2% of the nearly 7 million water heaters replaced in the U.S. annually;^{lxxxii} only 3.7% of single-family households generated electricity from distributed solar arrays as of 2020;^{lxxxiii} fewer than 20% of single-family homes have smart thermostats.^{lxxxiv} Adoption rates are even lower among low- to moderate-income and low-credit score households and renters.⁴³ While expected to grow on average nationally, adoption of DER technologies is uneven, and households and small businesses often face difficulty paying the upfront price of even the most cost-effective DERs, which can be more expensive than non-electric (and therefore not-VPP-eligible) equivalents. Low-credit-score consumers lack affordable financing to pay over time, and high-cost loans (e.g., credit cards) erode the energy-savings value of these purchases. These challenges have energy justice implications: if communities have low DER adoption, they may be excluded from the benefits of VPPs.

Challenge: DERs face installation hurdles in some service areas.

In some areas, consumers purchasing DERs, such as level 2 EV chargers and solar and storage systems, face installation delays caused by low electrician availability, unpredictable or lengthy building permitting processes, overloaded or saturated feeders preventing interconnection,⁴⁴ and other factors.

Potential solutions

Potential solution: Financial assistance for DER adoption, including low-cost financing, rebates, and tax incentives, particularly for low-income Americans. Actions may include:

- ▶ **Private and public financial institutions (e.g., community development financial institutions and green banks) could help finance DERs and VPP projects** on a state and local level.
 - ▶ Industry groups and consumer advocates may support these institutions with education on the benefits of DERs and VPPs to inform financial assistance strategies.
- ▶ **State and local organizations could further promote and deploy DER rebates and tax credits, including those made available by the Inflation Reduction Act.**⁴⁵
 - ▶ Consumer education and support is often needed to access these benefits. Community organizations, DER manufacturers, and other organizations can play catalytic roles.
 - ▶ State governments in particular may design DER adoption programs that incorporate VPP enablement and/or enrollment to advance policy goals.
- ▶ **Utilities could layer public incentives with their own DER adoption programs to grow active or latent DER capacity for VPPs;** example programs already in use include:
 - ▶ Financing programs with on-bill payment mechanisms offering lower interest rates than alternative consumer loans.^{46, lxxxv, lxxxvi, lxxxvii}
 - ▶ Rebates for qualifying technologies.
 - ▶ Leasing for solar-plus-storage systems.
 - ▶ Consumer education and technical assistance for DER choice and installation.
 - ▶ Partnerships with DER associations, businesses, and professional groups such as HVAC specialists, architects, engineers, renewable energy trade associations, and energy efficiency trade associations.

43 According to 2018 Census data, approximately two thirds of households are in multi-unit dwellings. Tenants typically do not have the right - nor the incentive - to modify buildings and equipment, such as by installing rooftop solar or EV chargers, deterring DER adoption among a large population of individuals and organizations.

44 VPPs are a solution to reducing feeder saturation by staggering flexible demand to shave peaks. DER adoption without VPP enrollment may be more likely to face delays.

45 For detail on available rebates, tax credits, and other support, see Making Our Homes More Efficient: Clean Energy Tax Credits for Consumers | Department of Energy; Energy Savings Hub | Department of Energy; Home Energy Rebate Programs | Department of Energy

46 Studies of utility-financed DER and energy efficiency programs have found strong repayment rates across low- and moderate-income consumers and, in some analyses, no obvious association between a program's underwriting criteria (including income and credit score) and participant default rates.

- *To support VPPs that manage flexible heating/cooling loads:* **Federal, state, and local governments, among other organizations, could support improved building weatherization and insulation,** particularly in homes of disadvantaged communities where the need can be acute. This will minimize impacts on the comfort and safety of VPP participants and improve the home's value to the VPP as a thermal battery when HVAC time-shifts to reduce strain on the grid.
- **Consumer advocate and Consumer Financial Protection Bureau engagement** can help align practices with consumer interests, particularly in DER finance/loan agreements.

Potential solution: Workforce development and good jobs for DER installation and maintenance.

Actions may include:

- **Utilities, DER manufacturers, VPP platforms and others can support workforce development in trades that are critical for the installation and maintenance of DERs.** These organizations can consider partnering with unions and trade organizations such as the International Brotherhood of Electrical Workers and National Electrical Contractors Association, for example by proactively pairing utility customers that have installation and maintenance needs with skilled electricians. Such partnerships can benefit utilities by increasing visibility into DER adoption patterns. Additional detail on workforce implications of VPP liftoff are outlined in *Section 3.iii, Broader Implications*.
- **State and local governments can consider adopting or revising building codes to promote adoption of VPP-enabled DER adoption,**^{47, lxxxviii} and augment personnel capacity of permitting agencies as needed.
- **State energy offices, regional energy efficiency organizations, DER and VPP industry groups can support permitting agencies** such as building code officials and fire departments with education to build understanding of the safety and potential benefits of DER technologies.

Potential solution: Equitable allocation of benefits from VPPs – including and beyond direct benefits to DER adopters – that prioritizes benefits for disadvantaged communities. Actions may include:

- **Utilities, regulators, and state policymakers can ensure equitable distribution of potential VPP benefits, including grid cost savings, good jobs, resilience and reliability benefits, and air quality improvements.**
- See *Section 3.iii, Broader Implications* for detail on potential solutions and actions.

⁴⁷ For example, NYSERDA publishes a voluntary Stretch Code for new buildings, which specifies that, "building controls shall be designed with automated demand-response infrastructure capable of receiving demand-response requests from the utility, electrical system operator, or third-party demand response program provider, and of automatically implementing load adjustments to the HVAC and lighting systems."

Example actions from the Department of Energy:

- **Loans and Loan Guarantees** to support VPP projects with a focus on low- to moderate-income communities, including lowering the cost of financing for VPP-eligible DER;
- **Home Energy Rebates** to reduce the cost of efficiency retrofits and electrification measures in homes and other buildings;
- **Weatherization Assistance Program** for energy efficient and electric technologies in low-income households, including improved insulation;
- **Technical Assistance for New and Stretch Code Adoption** for adoption and enforcement of new and stretch building codes;
- **Energy Efficiency Grants** for local governments, schools, and non-profits, including for deployment of DERs;
- **Energy Efficiency Loan Fund Capitalization Grants** to support energy efficiency projects, including distributed solar;
- **Residential and Commercial Workforce Training Programs** that include training on smart tech and grid network systems;
- **National Community Solar Partnership** to expand access to affordable community solar to every American household and enable communities to realize other benefits, such as increased resilience and workforce development.

4.ii. Simplify VPP enrollment

Key takeaways

- Participant acquisition costs can be high for VPPs due to low consumer awareness and costs of integrating DER software into third party VPP IT platforms.
- Automatic enrollment of DERs (with opt-out) could be a cost-effective solution for increasing VPP participation. Expanded consumer education will be critical.
- VPP-enablement could increasingly be built into DERs with features such as network connectivity and open-source application programming interfaces.

Challenges

Challenge: Consumer awareness is low and participant acquisition costs can be high for VPPs.

A lack of awareness and understanding of VPPs among electricity consumers drives up the cost of VPP marketing, consumer education, and enrollment. VPP platform companies typically bear high costs of finding, recruiting, and enrolling DER owners relative to DER manufacturers and retailers who interact directly with DER buyers or utilities with ongoing customer relationships. Enrollment costs increase further when OEMs impose fees on third-party VPPs to integrate with their DER software.

Potential solutions

Potential solution: Consumer education. Actions may include:

- **Environmental groups, social justice groups, consumer advocates, VPP companies, utilities and other electricity retailers, regional grid operators, DER manufacturers, DER installation and maintenance professionals, and government leaders all have a role to play in educating**

electricity consumers about VPPs and opportunities for participation. In particular, community organization-led VPP education efforts can increase trust and ensure community members' interests are prioritized.

- **Off-takers such as utilities and ISOs/RTOs can consider longer-term VPP contracts** (five years or more) to de-risk a VPP platform's investment in consumer education and marketing.

Potential solution: Automatic enrollment at point of DER purchase with opt-out. Actions may include:

- **DER manufacturers, retailers, and installers can consider enrolling consumers in VPPs at the point of purchase**, when they are thinking most critically about the value and functionality of their DER. This may mean either enrolling the consumer in an existing VPP to increase local VPP capacity or recording their interest in potential future VPP opportunities once available.^{48, lxxxix} Launching a VPP is sometimes referred to as a 'chicken and egg' problem: A DER aggregator or utility may invest in a VPP platform only if a sufficient population of DERs will enroll; meanwhile, for some consumers, collecting VPP rewards as way to offset the cost of the DER may make or break the purchase decision. Proactively identifying and aggregating available DER capacity through automatic enrollment has the potential to catalyze VPP deployment.^{49, xc}
- **Consumer advocates could shape enrollment and opt-out mechanisms to ensure consumer satisfaction and protection, and to help navigate VPP options.** As VPPs become mainstream, customers will have different options to select from. Trusted resources that explain VPP participation requirements and compensation rates will be increasingly needed.
- **In parallel, VPP companies and utilities could work to create positive participant experiences and deliver excellent customer service to prevent churn.** VPPs must respect participant comfort and convenience with the understanding that a DER's role in providing grid services is secondary to its functions to the consumer as a vehicle, heating system, backup power, or otherwise.

Potential solution: VPP-enablement standards or requirements for DER manufacturers. Actions may include:

- **Policymakers can consider expanding usage of criteria for DER hardware that enable grid services.** For example, the EPA currently maintains connected criteria for certain ENERGY STAR product categories where network connectivity enables additional opportunities for energy savings and grid benefits,^{50, xci} and the Consortium for Energy Efficiency maintains similar criteria for certain products.^{xcii} When weighing how to apply these criteria, policymakers could take into account both the incremental manufacturing costs passed on to the consumer and the expected benefits for the consumer. Criteria may be as simple as delayed start buttons on appliances, or they may be relatively more complex, such as built-in energy metering.
- **Policymakers can consider mandating that manufacturers of DERs use open source APIs that streamline DER integration into third-party IT systems.** This can reduce aggregation costs and IT implementation complexity for the VPP provider.

48 Opt-out structures among Community Choice Aggregators (CCAs) may be an instructive analog for VPP enrollment. According to interviews with CCAs, typical opt-out rates are on the order of 5%–15%, meaning about 85%–95% of eligible customers remain in CCAs. In contrast, top-performing voluntary (opt-in) utility green pricing programs achieve program participation rates on the order of 5%–20% (NREL 2018)

49 In a test of the effects of streamlining enrollment, Uplight integrated demand response program pre-enrollment into the online purchase process for smart thermostats and found four times more enrollments than with typical processes where customers must visit a separate website to sign up.

50 For detail, see Connected Criteria for Partners, EPA.

Example actions from the Department of Energy:

- **Roadmap for deployment of Grid-interactive Efficient Buildings** publication;
- **Connected Communities**, a scaled demonstration of the technologies and approaches to VPP deployment;
- **Smart Grid Grants** to increase the flexibility, efficiency, and reliability of the electric power system;
- **National EV Infrastructure Standards** that ensure federally-funded charging equipment is capable of smart charging;
- **V2X MOU** partnership and business case demonstration projects that identify interconnection standards, market access needs, and interoperability approaches for charging and discharging with public and private sector engagement;
- **Computational tools** developed and applied by National Laboratories to help regulators and utilities determine how to apply DER, including microgrids, to better serve equity and resilience needs.

4.iii. Increase standardization in VPP operations

Key takeaways

- Some utilities perceive VPPs as less predictable than traditional assets because forecasting and performance measurement methods vary widely among VPP service providers. Limited publicly available data on historical VPP performance makes it challenging to underwrite performance guarantees.
- Part of the difficulty in scaling up proven VPPs across geographies stems from inconsistencies in key areas of distribution system operations, including grid participant governance, electricity data measurement and communication, DER interconnection and product certification, and cybersecurity. When these operating parameters all must be negotiated in setting up a VPP, transaction costs are high, and timelines are long.
- Standardizing VPP operational approaches — and management of distribution systems more broadly — could accelerate VPP integration in retail and wholesale markets (*Imperatives 4 & 5*). Standards must be designed and managed to evolve over time
- To date, such standardization has progressed organically; improved coordination and resourcing is needed to develop coherent industry- and regulator-aligned standards on timelines that meet electrification goals.

Challenges

Challenge: VPPs are perceived by some utilities as less predictable than traditional assets because forecasting and performance measurement methods vary widely among service providers, and because of a lack of publicly-available historical performance data.

Some believe that for VPPs to perform predictably, DERs must individually be predictable. However, the aggregate performance of a VPP can be predictable with appropriate historical data and forecasting models—similar to other portfolio approaches to managing uncertainty. Today, modeling approaches for VPPs differ across service providers and are not always transparent. Differences proliferate in areas such

as: forecasting VPP performance for future planning purposes, controlling VPP performance in ongoing operations, and measuring and verifying VPP impacts after grid services have been delivered.

Variations in service agreements and codes of conduct across different types of DERs, off-takers, and states slow the scale-up of proven VPPs.⁵¹ Service agreements specify discrete services and related performance expectations from DER service providers, including requirements for visibility into individual DERs, operational coordination protocols, compensation for services, performance evaluation methods, and customer consent requirements (e.g., electronic opt-in vs. wet signature). In some cases, variation is driven by underlying (incompatible) IT and operational systems; in others, it is driven by internal organization policies.

Challenge: In some cases, there is a lack of consistent standards for the underlying technologies of VPPs, including collection and communication of electricity data, product certifications, and DER interconnection.

Electricity data content and format (e.g., data fields, time resolution) used by grid actors varies widely. Barriers to data sharing obstructs accurate needs assessments, forecasting, and performance measurement and verification, all of which significantly increases transaction cost. Data sharing across organizations is limited by a combination of factors, including privacy concerns, the desire to maintain a competitive advantage in the marketplace, incompatible IT systems, and in some cases a lack of data collection hardware and software on distribution system infrastructure. Standard data formats that could be shared across organizational platforms and between systems are needed.

Only applicable to DERs requiring interconnection (e.g., batteries, distributed solar): A proliferation of different interconnection standards leads to complexity for some DER technologies while there is a lack of standards for others. Underlying reasons include divergent utility preferences and IT systems, state interconnection standards, and OEM policies. This issue is technology-specific; for example, it is not an issue for most flexible demand DERs, but is a challenge for distributed solar and some EV chargers.

Challenge: Cybersecurity best practices have not yet been uniformly adopted, which creates both real and perceived risks for VPP deployments.

Integration of a higher volume of DERs into the grid may create a greater attack surface for malicious intruders if attackers compromise a DER vendor, VPP operator, or other party. Best-practices in mitigating risk of grid operations disruptions have been identified but not widely adopted. The cybersecurity practices for distribution-level VPPs will need to be specified at the state level or by the interconnecting utility, which could create a hodgepodge of standards and requirements. A lack of commonly accepted measures adds friction and cost to service agreement negotiations, and failure to implement appropriate risk mitigation approaches may introduce system risks.

Potential Solutions

Potential solution: Common, open source DER and VPP modeling tools to help engineers predict and manage performance, including datasets, predictive models, and measurement methods.

Actions may include:

- **Private companies and research organizations, such as national labs, could promote adoption of, and continue to develop, open source databases for key inputs into VPP models.** Examples may include high-resolution building and household-level electricity consumption data and EV charging data in granular time increments, including measured responses to grid signals and incentives under an array of conditions (i.e., compliance rates for a range of paid incentives).
- **These stakeholders could also release and curate open source, trusted probabilistic models to forecast VPP performance** (e.g., demand shifting, energy dispatch, ancillary services) that can be applied across geographies to expedite location-specific pilots and data collection. Establishing

⁵¹ For example, a VPP platform company leader reported that across 20 VPP operations, 16 were so unique that staff could not be shared across them.

standard, transparent approaches for guaranteeing VPP performance and assuring the delivery of DER services—including underwriting known risk and/or adjusting capacity factors—could accelerate integration of VPPs in both utility applications and wholesale markets. *See appendix for examples of modeling tools available from select DOE-partnered National Laboratories.*

- **Standardized methodologies for measuring and verifying the performance and delivered benefits of VPPs for settlement are also needed** – e.g., to estimate baseline electricity usage vs. the VPP-driven outcome.^{52, xciii}

Potential solution: Industry-wide standard VPP service agreement(s) that include performance guarantees. Actions may include:

- **Regulators, utilities, regional grid operators, and other VPP leaders could codify a set of accepted measures to minimize VPP performance risk within accepted and understood bounds;** for example, a set of standard over-enrollment ‘buffer’ factors that account for potential participant (DER owner) event opt-out.
- **VPP companies and off-takers, such as utilities, could establish and adopt standard language that outlines terms and conditions between an aggregator and a utility and/or between an aggregator and participants to accelerate new VPP design and counterparty negotiations.**⁵³ The templates could include a series of standard add-on annexes for common DER types that outlines DER-specific telemetry requirements (where relevant), operational limits, and settlement processes (including measurement and verification).

The following potential solutions are proposed areas for standardization of overall distribution system operations (not specific to VPPs) that would enable more consistency and repeatability across VPP deployments, including the models, data, measurement tools, and service agreements described above.

Potential solution: Industry- and regulator-aligned distribution system reliability standards and a holistic set of grid codes to govern grid participants and their operations. Actions may include:

- **Research organizations, regulators, utilities, and regional grid operators could accelerate research, development, and adoption of distribution system reliability standards and requirements.** This could involve extending existing requirements from transmission systems (regulated by NERC) to distribution systems (regulated by states) with appropriate adaptations.⁵⁴ These standards could be structured to reflect the changing nature of grid operations, and DERs and VPPs could be treated as critical infrastructure as they scale up to become critical resources for a growing number of utilities.
- **DOE, in partnership with research organizations, utilities, regional grid operators, and other VPP industry leaders could help establish grid codes** – operational coordination frameworks that govern the relationships of all participants (DER aggregators, distribution system operators, and bulk-level-system operators) in the provision and management of electric grid services, including from VPPs. Standardization becomes especially important as the use and sophistication of DER aggregation services becomes increasingly common and automated in addressing system dynamics.

52 In an example of a jurisdiction building alignment, CAISO publicly supported an open-source methodology for measuring demand response (FLEXmeter) after testing it across 24,000 residential and commercial customers participating during California’s 2022 heatwave.

53 As an analogy, consider master agreements common in commodities future trading: International Swaps & Derivatives Association forms. They can include items such as contract term, communication processes, compensation, payment mechanisms, confidentiality, credit requirements, dispute resolution, and more.

54 Standards should be developed in a transparent manner and phased in over time to avoid over-burdening legacy systems.

Potential solution: A narrowed set of DER interconnection standards & technology and data standards. Actions may include:

- **DOE, research organizations, grid operators, and VPP industry leaders, could map where a lack of standards or, conversely, a proliferation of standards creates friction in grid operations and develop a path forward.**^{55, xciv} Creating seamless data flow between aggregators, consumers, VPP platforms, and utilities has the potential to substantially lower transaction costs for VPP deployments. Key areas for alignment include:

 - ▶ Data and device interoperability (communications interfaces between DERs, DERMS, legacy systems, and other grid actor systems).⁵⁶
 - ▶ Data privacy standards.

Potential solution: Dissemination and adoption of nationally recognized baseline cybersecurity measures for distribution system participants. Actions may include:

- **Regulators, utilities, and VPPs companies could incorporate and/or require common baseline cybersecurity measures and responsibilities that ensure systems are secure by design and operated for resilience.**^{57, xcv} Measures may include, for example, multifactor authentication, endpoint detection and response, and encryption.^{xcvi} Responsibilities may include methodologies for assessing risk, planning risk-mitigation measures, and funding and implementing cost-effective measures in ways that are consistent across geographies.^{58, xcvi}
- **To further mitigate cyber risk, all grid actors – particularly those using cloud-based IT architecture – can contribute to collective defense by sharing information on threats.** National information sharing mechanisms include the Electricity Information Sharing and Analysis Center and partnering with DOE’s Energy Threat Analysis Center Pilot efforts in the future.^{xcviii}

55 This effort can build on the National Institute for Standards and Technology (NIST) Framework and Roadmap for Smart Grid Interoperability Standards Access. For detail, see release 4.0.

56 Work is ongoing across industry groups to create common standards for integrating DERs into grid management. Examples for EV infrastructure include the American National Standards Institute’s Electric Vehicles Standards Panel Roadmap and the Open Vehicle Grid Interface Protocol (OVGIP); OVGIP is a common communication language for EVs and the grid developed by auto industry and energy industry groups. An example for smart home devices is Matter, an interoperability standard developed by The Connectivity Standards Alliance with support from Amazon, Google, Apple, and Samsung, and others. Another example is OpenADR, which standardizes the message format used for Auto-Demand Response and DER management so that dynamic price and reliability signals can be exchanged in a uniform and interoperable fashion among utilities, ISOs, and energy management and control systems.

57 DOE is collaborating with NARUC, industry, and other partners on developing baseline measures for distribution system cybersecurity that can provide direction for industry standards and/or requirements mandated by states. For more recommended actions on integrating cyber resilience into the design, implementation, operation, and maintenance of energy infrastructure and embedded energy systems, see the DOE’s 2022 National Cyber-Informed Engineering Strategy.

58 Responsibilities, rather than static requirements, are recommended to avoid bare-minimum compliance or stifling innovation. For more information, see the Department of Energy’s work on Cybersecurity for Distribution Systems, including, Cybersecurity Considerations for Distributed Energy Resources on the U.S. Electric Grid and Report on Cybersecurity of Distribution Systems.

Example actions at the Department of Energy:

- ▶ **Grid Solutions program**, a collaboration with regulators and utilities to define coordination and system requirements to enable the utilization of grid services from DERs and VPPs:
 - ▶ Developing grid codes, standard service agreements, and codes of conduct governing business, market, and technical operational requirements of all participants in the provision and management of services from DERs;
 - ▶ Developing standard reference designs for the distribution grid to enable DERs utilization and orchestration;
 - ▶ Developing guidelines on the staged deployment of foundational and co-dependent grid assets to enable the utilization and orchestration of DERs and incorporating them into planning guidelines for regulators;
- ▶ **Distributed Energy Resources Cybersecurity Risk Assessment and Mitigation** report publication;
- ▶ **Distribution system cybersecurity baselines** development as part of the National Cybersecurity Strategy, led by NARUC through DOE funding;
- ▶ **Cyber-Informed Engineering Strategy** development for energy system architecture;
- ▶ **Energy Threat Analysis Center** launch for cybersecurity threat collaboration between industry and government to enable collective defense;
- ▶ **VPP-related research, development, and deployment programs focused on systems integration** (including SHINES, ENERGISE, Solar Forecasting, resilient community microgrid):
 - ▶ Development of inverter and power system models, optimal control algorithms, software tools such as DERMS, grid services from inverter-based resources and DERs, and solar generation and net load forecasting;
 - ▶ Testing at the National Renewable Energy Laboratory's Advanced Research on Integrated Energy Systems facilities for solar-plus-storage;
 - ▶ Interconnection Innovation Exchange (I2X) and other programs for the development of interconnection standards for inverter-based resource and DERs to ensure system reliability;
 - ▶ Cost-benefit analysis support for VPP solutions involving distributed solar and energy storage;
- ▶ **Building Energy Codes Program** to support development, adoption, implementation, and enforcement of codes to achieve energy efficiency;
- ▶ **EVs@Scale National Laboratory Consortium** that brings together national laboratories and key stakeholders to conduct research and development to address challenges and barriers for high-power EV charging infrastructure to enable greater safety, grid operation reliability, and consumer confidence.

4.iv. Integrate into utility planning and incentives⁵⁹

Key takeaways

- Familiarity with VPPs remains low nationally among utility regulators.
- Utility planning requirements and compensation structures are often not aligned with system-optimal VPP deployment. Revising these frameworks is challenging for regulators and different across jurisdictions.
- Technical assistance (including personnel increases) for utility regulators could help expand effective practices such as integrated distribution system planning, performance-based rate design, and all-source procurement that increase consideration of VPPs in grid management decisions.
- State legislators can consider introducing or revising policies to promote VPP deployment in line with state goals (e.g., affordable electricity, grid resilience, decarbonization).
- Utilities that have not yet integrated VPPs into grid operations can consider proactive measures – e.g., distribution system mapping, load forecasting, customer incentive design – to begin deploying VPPs that can grow as DER adoption accelerates.

Challenges

Challenge: Familiarity with VPPs remains low nationally among utility regulators, including PUCs/PSCs, the boards of rural electric cooperatives and public power utilities, and state policymakers.

While awareness of DERs is common, many regulators not familiar with approaches for integrating and utilizing DERs in VPPs to provide valuable grid services reliably and cost-effectively. This lack of familiarity with potential use-cases and demonstrated successful deployments can lead to skepticism about VPP performance.

Challenge: Existing methods for valuing services from VPPs and DERs are not comprehensive.

Valuation of potential VPP benefits in grid planning and operations varies based on state and local priorities as determined by legislators, utility regulators,^{60, xcix} boards of municipal utilities and rural electric cooperatives, community groups, utilities, and regional grid operators. In this context, the lack of comprehensive valuation tools handicaps VPPs in two ways. First, when cost-benefit analyses of a VPP (vs. an alternative grid resource) underestimate or exclude VPP benefits, VPPs are less likely to be integrated into utility plans. Second, under-compensation (relative to system value created) limits a VPP's ability to reward – i.e., recruit and retain – participants. Benefits that are often excluded or under-valued include, but are not limited to: resilience, greenhouse gas emissions reduction and climate benefits, improved air quality, reduced T&D congestion, and socioeconomic benefits for communities.

Challenge: Aligning utility planning requirements and compensation frameworks for system-optimal VPP deployment is complex and evolving.

Within state utility regulation frameworks, VPPs span areas managed separately, and regulatory requirements and practices vary by state. Even in light of their diversity, existing planning and compensation frameworks face common challenges when it comes to improved integration of VPPs.

- A minority of states (about 20) require regulated utilities to file distribution plans that address the integration and utilization of DERs (among other issues).^c Relatedly, regulators and utilities are challenged with determining rational, staged approaches for deploying grid technology to enable the integration, utilization, and orchestration of DER-based assets and the services they provide.

⁵⁹ State policies and the treatment of VPPs in utility regulations vary widely; the following challenges do not apply to all states/jurisdictions.

⁶⁰ Few state commissions use societal cost-benefit calculations today. For detail, see Lawrence Berkeley National Laboratory's [Database of Screening Practices](#).

- Common capex-driven compensation schemes create utility financial disincentives for VPP deployment. Approaches are needed for considering shared investments between utilities and third-party service providers, or shared savings between utilities and customers.⁶¹
- VPPs span topic areas that have traditionally been handled through separate processes—for example, planning processes, procurement procedures, energy efficiency programs, demand response programs, and ratemaking.
- Methods for integrating DERs via VPPs are evolving and require new methods to evaluate their cost-effectiveness given utility operations and constraints.

Challenge: PUCs/PSCs may lack the resources, expertise, and/or capacity needed near-term to a) revise regulations, and b) scrutinize utility distribution and resource plans that do not consider VPPs and/or the full range of VPP benefits.

In some cases, a shortage of personnel bandwidth limits the speed of progress. Regulators often lack the financial resources and personnel to undertake efforts to fully understand and assess needed regulatory changes, especially as the potential for grid services from customers and third-parties continues to expand.

Potential solutions

Potential solution: Comprehensive valuation of VPP benefits to improve cost-benefit assessments in distribution system planning, and to inform state and local policy decisions. Actions may include:

- **National laboratories and other public and private leaders in energy analytics can continue to develop and help deploy modeling tools that more comprehensively value VPPs.**⁶² This may involve new tools and/or adapting the use of existing tools to more holistically value VPP benefits.
- **In addition to modeling tools that estimate VPP benefits, decision tools that incorporate such benefits into policy decisions could help state and local policymakers shape utility planning objectives.** For example, state policymakers may decide to require utilities to consider a comprehensive set of societal costs and benefits in planning decisions, or may decide to introduce mandates for investments in resilience, decarbonization, or equity (via VPPs or otherwise). Communities and utilities should be engaged in decision-making for such investments.

Potential solution: Integrated distribution system planning requirements for utilities. Actions may include:

- **Public and private sector stakeholders could increase resources for new or existing⁶³ technical assistance programs for utility regulators to support distribution system planning practices.** Enhanced planning practices can help to understand the evolution of consumer DER and their interaction with the grid, and to formulate foundational grid investment strategies aligned with policies and customer interests.^{64, ci} Plans should integrate with regional transmission planning, and consider long-term (more than five years) forecasts and scenarios for electricity demand, DER adoption, and climate parameters.
 - ▶ A key enabler of such planning is visibility into distribution system constraints—for example, hosting capacity maps. Such maps can be paired with information on the location of existing and anticipated

61 Where technological upgrades, such as systems for enhancing the visibility and orchestration of DER assets, are required to enable VPPs, decisionmakers who formulate and approve grid investments must determine the staged strategy for deploying these upgrades and their associated costs.

62 Deployment support for regulators and utilities may include publishing guides, hosting webinars, posting videos, and direct technical assistance.

63 Existing programs are operated by organizations such as Lawrence Berkeley National Laboratory, Regulatory Assistance Project (RAP), NARUC, RMI's Virtual Power Plant Partnership (VP3), and others. For example, NARUC publishes guidance for PUCs/PSCs, hosts workshops, and provides financial tools. In their initial member convening last spring, VP3 set goals of advancing VPP research and communication, convening utilities and regulators, and developing policy strategies to support deployment.

64 For example, the Orlando Utilities Commission used a distributed energy generation forecasting tool developed by the National Renewable Energy Laboratory (the dGen modeling tool) to support the development of a long-term Clean Energy plan. The building-level granularity of the model gave the Commission visibility into the potential scale and likely location of distributed solar generation resources through 2050, and ultimately led planners to pull forward the target retirement date for coal resources.

grid assets, such as EV charging and storage, to direct VPP deployment (and any necessary supporting grid investments) to the highest-value locations.⁶⁵

- **State legislators can consider mandating integrated distribution system planning.** Where not already in place, states can consider requiring utility planning practices that address state goals (including on decarbonization, resilience, and equity).

Potential solution: Alignment of utility incentive structures and rate design for system-optimal (cost-effective, reliable, clean, equitable) resources. Actions may include:

- **Public and private sector stakeholders could increase resources for technical assistance to support implementation of measures such as:**
 - ▶ **Performance-based payments or rate design.** Utility compensation can be tied to goal outcomes such as energy efficiency,⁶⁶ emissions reduction, resilience, capex deferral, or other.^{67, cii}
 - ▶ **Potential modification of cost recovery practices.** Modifications could allow utilities to capitalize the costs of VPPs (e.g., implementation of software platforms, participant recruitment) that would otherwise be treated as operational expenses.
 - ▶ **Advanced rate design that better reflects the hourly cost and/or emissions intensity of electricity.** Advanced rates, such as time-varying rates, have the potential to help balance supply and demand and can create energy arbitrage opportunities for some types of VPPs. Utilities may consider that over time, a high number of DERs used by consumers responding to the same peak vs. off-peak prices may result in new demand peak times to manage. The active management of DERs by a VPP (for example, to strategically stagger overnight EV charging, or to adapt in real-time to an unexpected generation shortfall) may offer higher value while placing less onus on consumers' attention and behavior change.
 - ▶ **Updated procurement processes,** including 'all source' procurement open to VPPs.
- **State legislators and regulators can consider direct measures, such as requirements that utilities use all system-optimal VPPs or that VPPs must be included in distribution and integrated resource planning practices where cost-effective and otherwise aligned with state energy goals.** Indirect measures may include clean energy mandates (e.g., renewable portfolio standards) that incentivize integration of distributed solar, building electrification programs that promote DER adoption, among others.

Potential solution: Proactive leadership among utilities – in collaboration with regulators – in VPP planning and investment proposals.^{68, ciii, civ} Actions include:

- **Utilities and other load serving entities who have not yet integrated VPPs into grid operations can consider taking the following initial steps^{cvi}:**
 - ▶ Convert policies, consumer preferences, and DER adoption forecasts into a set of objectives – e.g., increasing renewables mix, mitigating grid impacts of building and transportation electrification, reducing emissions of air pollutants.
 - ▶ Consider potential customer incentives and rate structures that optimize VPP benefits for both the grid and utility customers.

65 Hosting capacity maps and load serving capacity maps can be used by developers to identify locations where interconnection is viable (e.g., for EV charging infrastructure, community solar, and other projects), which eliminates wasted time prospecting in areas with grid constraints. Additionally, granular visibility into grid conditions helps utilities determine a local avoided cost value of a non-wires alternative that would be reflected in VPP compensation. This, in turn, can direct targeted, location-specific VPP participant recruitment. One potential solution to increase DER location visibility is a voluntary, cross-utility DER registry, such as that coordinated by nonprofit group Collaborative Utility Solutions.

66 Energy efficiency programs must take into account the hour of demand reduction to create incentives for VPPs to manage peaks.

67 For detail, see 'Demand Flexibility within a Performance-Based Regulatory Framework,' NARUC 2023.

68 Examples of utilities already integrating VPPs at scale into operations and planning include: Otter Tail Power Company has an existing demand response portfolio that represents 15% of system peak (winter); Dakota Electric Association has over 40% of members participating in a demand response program and can reduce approximately 25% of peak demand with managed load assets; Portland General Electric has a goal that by 2030, VPPs will enable customer choices for shifting energy use that will deliver a 25% reduction in peak load.

- ▶ Undertake granular DER adoption and load forecasting as part of integrated distribution planning to understand investment needs.
- ▶ Evaluate costs and benefits associated with addressing locational and temporal grid needs.

Example actions from the Department of Energy:

- ▶ **Grid Innovation Program** that provides financial assistance to states, Tribes, local governments, and public utility commissions to deploy projects that use innovative approaches to T&D and storage infrastructure to enhance grid resilience and reliability;
- ▶ **Integrated Distribution System Planning Training and Guidelines** development to assist regulators in developing requirements for, and in assessing, integrated distribution plans of utilities that consider integrating and utilizing DER services, as well as in understanding needed investments;
- ▶ **Clean Energy Innovator Fellowship** funds recent graduates and energy professionals to support public utility commissions, co-ops, Puerto Rican energy associations, tribal utilities, and other grid operators;
- ▶ **State Energy Program** provides funding and technical assistance to enhance energy security, advance state-led initiatives, and increase energy affordability;
- ▶ **DER Compensation Initiative** to engage regulators via a cooperative agreement with the National Association of Regulatory Utility Commissioners.

4.v. Integrate into wholesale markets

Key takeaways

- ▶ FERC Order No. 2222 instructs ISOs/RTOs to allow participation of VPPs directly in wholesale markets.
- ▶ Implementation timelines and VPP participation requirements vary by region, and multiple ISOs/RTOs are facing significant challenges, including IT limitations and personnel capacity constraints, that must be addressed.

Challenges

Challenge: Due to institutional and technological hurdles in implementing FERC Order 2222, some ISOs/RTOs have proposed timelines as long as 2030 or conservative participation requirements.

How and when ISOs/RTOs implement FERC Order 2222 will determine a VPP's ability to participate in the region's wholesale markets. Multiple ISOs/RTOs cite operational barriers to timely and inclusive integration of VPPs. For example, Midwest Independent System Operator's (MISO) proposed plan would permit VPPs to participate in 2030; reasons include a prerequisite, multi-year update to legacy software systems.⁶⁹

^{cv} New York Independent System Operator (NYISO) proposes a minimum capacity of 10kW for each individual DER in any aggregation in order for a VPP to be eligible for participation (this would exclude many residential DER types); reasons include a lack of personnel capacity to manage enrollment and auditing of a high volume of DER.^{70, cvii}

⁶⁹ In its April 2022 letter to FERC, MISO wrote, "benefits of these aggregations are unknown and relatively limited by the existing retail regulatory construct in many of the states in the MISO Region... potential quantity of distributed energy resource aggregations, both number of aggregations and capacity in megawatts, is unknown."

⁷⁰ In a September 2022 presentation, NYISO wrote, "Given the NYISO's current technical resources and capabilities for initial DER deployment, allowing small (<10 kW) DER will require a substantial amount of additional manual work in order to complete tasks that are core to the timely participation of DER."

Specific hurdles cited across ISOs/RTOs include:

- Gaining sufficient real-time visibility of the state of DERs and whether they can be dispatched at a given time depending upon the operating requirements of the distribution system;⁷¹
- Having agreements and supporting processes in place relating to ensuring participating DERs comply with eligibility, dispatchability, and data flow requirements to support grid, market and settlement operations;
- Having the appropriate control technologies in place to enable the orchestration of DERs so they can provide services to the grid and/or customers in a reliable manner at large scale.

Potential solutions

Potential solution: Targeted support for ISOs/RTOs to accelerate IT upgrades, augment personnel, and resolve operational barriers to integrating high volumes of DERs into planning and management of bulk power systems. Actions include:

- **DOE can consider playing a more active role in convening industry – utilities, regulators, VPP platform companies, individual DER owners – to determine requirements.** For example, technical assistance programs supported by DOE and national labs may be directed at providing near-term IT and personnel support to accelerate and expand VPP participation in wholesale markets. This may include enhanced planning processes for ISO/RTO to capture opportunity to use VPPs for capacity and reliability.
- **Long-term, ISOs/RTOs may consider introducing new products defined specifically for VPPs (e.g., flexible demand) with fit-for-purpose performance expectations, eligibility criteria, and metrics that balance cost to implement with expected system-wide benefits.**

Example actions from the Department of Energy:

- **Operational Coordination Guidelines** development, vetting, and dissemination that address the roles and responsibilities of all participants (DER owners, VPPs, distribution system operators, bulk system operators, and regulators) to support DER integration and scale use of DER services;
- **Technical assistance** for the use and applications of DERs to support distribution and bulk power system operations for ISO/RTOs, regulators, states, and communities;
- **Grid Resilience Utility and Industry Grants** that fund comprehensive transformational transmission and distribution technology.

⁷¹ Examples of operational complexities include: Protection schemes to ensure that customer and grid systems are protected from over-current or over-voltage situations, especially in the case of bi-directional flow with VPPs; Voltage and reactive power management; Outage management, including potential need to isolate a portion of the grid on short notice; Right-sizing of lines, transformers, and other equipment to handle bi-directional flow; and more.

Chapter Five: Metrics to Track Progress

Given the influence of jurisdiction-specific utility regulation and energy policy over the viability of VPP deployment, metrics should be tracked at the regional, state, and/or utility level. Community and/or demographic detail should be captured to track benefits distribution and alignment to Justice40 Initiative.

Three categories of metrics should be tracked:

- **Outcomes** track the value created by VPPs as relates to broader social and environmental goals.
- **Leading indicators** signal market readiness for DER and VPP adoption and growth.
- **Lagging indicators** track observed progress toward VPP Liftoff.

The following non-exhaustive list presents potential categories of metrics.

VPP Liftoff	Outcome
<i>Potential value of VPPs at scale</i>	<ul style="list-style-type: none"> ➤ Affordability of electricity as a result of, for example: <ul style="list-style-type: none"> ▶ Peak demand reductions and associated infrastructure investment deferral (transmission, distribution, and/or generation) ▶ Reduced electricity consumption due to energy-efficient DERs ▶ Increased utilization (capacity factor) of T&D infrastructure and clean generation assets ➤ Reliability and resilience benefits as indicated by, for example: <ul style="list-style-type: none"> ▶ Avoided outages ▶ Shortened outages ▶ Reduced number of end users impacted by outages ➤ Greenhouse gas emissions and air pollution reduction as a result of, for example: <ul style="list-style-type: none"> ▶ Reduced procurement from fossil-fueled peaker plants, net of potential emissions from increased use of non-peaking generation assets ▶ Reduced curtailment of utility-scale renewables assets (and potential long-term implications for increased renewables deployment), as well as increased utilization of clean firm generation resources ➤ Community benefits including energy job creation and retention associated with DER and VPP deployment, and associated indicators of job quality and workforce equity (e.g. wages, benefits, workforce demographics)

Imperative	Leading indicators	Lagging indicators
<i>Expand DER adoption with equitable benefits</i>	<ul style="list-style-type: none"> ➤ Capital deployed for low-cost financing of DERs and associated DER adoption support (e.g., home weatherization) ➤ DER rebate and tax incentive uptake ➤ Building codes that promote VPP-enabled DER adoption ➤ Workforce development initiatives related to DER and VPP deployment 	<ul style="list-style-type: none"> ➤ Available DER capacity, by type, that indicates the potential scale of VPP grid services: <ul style="list-style-type: none"> ▶ DER nameplate capacity by type (MW flexible demand; MW distributed generation; MW and MWh distributed storage) <ul style="list-style-type: none"> » EVs, EV chargers (unidirectional, bidirectional) » Smart thermostats / electric HVAC, incl. heat pumps » Smart electric water heaters » BTM batteries » Distributed solar » Others ▶ Flexible capacity factors by type, where relevant ➤ DER capacity / adoption rates ➤ Good jobs created and/or retained
<i>Simplify VPP enrollment</i>	<ul style="list-style-type: none"> ➤ Consumer awareness of VPPs ➤ Adoption of enrollment streamlining measures; examples include: <ul style="list-style-type: none"> ▶ Automatic enrollment with DER purchase among DER manufacturers and retailers ▶ Open-source application interfaces for DER software 	<ul style="list-style-type: none"> ➤ Enrolled VPP participants and enrolled DERs ➤ DER capacity enrolled in VPPs <ul style="list-style-type: none"> ▶ Energy ▶ Capacity ▶ Ancillary services ▶ Potential new products
<i>Increase standardization in VPP operations</i>	<ul style="list-style-type: none"> ➤ Public and private sector collaboration and resourcing for the development of VPP operational standards ➤ Public and private sector collaboration and resourcing for the development of distribution system standards 	<ul style="list-style-type: none"> ➤ Breadth of adoption of open-source forecasting, planning, operations, and measurement tools (data sets, modeling methods) related to DER and VPP deployment ➤ Standardization of VPP service agreements across jurisdictions; for example: <ul style="list-style-type: none"> ▶ Reduction in number of different interconnection standards across utilities for a given DER ▶ Common data standards and data sharing policies ▶ Cybersecurity baselines

Imperative	Leading indicators	Lagging indicators
<i>Integrate into utility planning and incentives</i>	<ul style="list-style-type: none"> ▶ Favorable regulatory frameworks for VPP to participate in retail markets; examples include: <ul style="list-style-type: none"> ▶ Long-term integrated distribution system planning requirements (including DER adoption scenarios) ▶ Non-wire alternatives requirements ▶ Performance-based ratemaking ▶ Inclusive procurement processes that permit participation from VPPs (e.g., 'all source procurement') ▶ Energy efficiency resource standards 	<ul style="list-style-type: none"> ▶ Number of utilities and community choice aggregators using VPPs to address 10-20% or more of forecasted peak demand ▶ Total VPP capacity procured, (and utilized) in a given year <ul style="list-style-type: none"> ▶ Energy ▶ Capacity ▶ Ancillary services ▶ Potential new energy products
<i>Integrate into wholesale markets</i>	<ul style="list-style-type: none"> ▶ Favorable regulatory frameworks for VPP to participate in wholesale markets; examples include: <ul style="list-style-type: none"> ▶ FERC 2222 Implementation timing and approaches 	<ul style="list-style-type: none"> ▶ Total VPP capacity procured, (and utilized) in a given year <ul style="list-style-type: none"> ▶ Energy ▶ Capacity ▶ Ancillary services

Appendix

I. Key concepts and terms in this report

Behind the meter (BTM) vs. Front of the meter (FTM)

'**BTM**' describes assets that are located on the customer's side of the electricity meter. '**FTM**' describes assets that are directly connected to the electricity grid, in front of a customer's meter. FTM assets do not contribute to or offset a customer's metered load, though they may be located on the same site as a customer. VPPs may include DERs that are both BTM and FTM.

Demand response

Demand response is the practice of curtailing consumption in response to peak demand signals from grid operators. Responses include, for example, turning down HVAC systems, or rescheduling industrial production line operations.

Energy & capacity (nameplate capacity, flexible capacity)

Energy is the amount of energy produced or consumed over time, measured in kilowatt hours (kWh). **Capacity** refers to the maximum point-in-time output (for generation or storage assets) or maximum draw (for demand assets) of electrical equipment, measured in kilowatts (kW).

In some markets, utilities may procure electricity **capacity** to draw on during a specified future window of time — essentially a forward energy option. For example, a utility may procure 100 MW of capacity for a future two-hour window, then later draw up to 100 MW for those two hours — i.e., up to 200 MWh of energy.

Nameplate capacity is the maximum power draw or power output of an energy asset as defined by the manufacturer. For example, a fast EV charger has a higher nameplate demand capacity than a water heater because it draws more energy. A large array of solar panels has a larger nameplate

generation capacity than a small array. Storage DER have both point-in-time maximum electricity output (nameplate capacity measured in kW) and maximum amount of energy stored (nameplate storage capacity measured in kWh).

In this report, **flexible capacity** of a DER refers to the actual capacity available for a VPP to manage. Conversion from nameplate capacity to flexible capacity involves variables that differ by DER type. For example, the flexible capacity of an EV charger available to a VPP in a given window of time depends on when and for how long a vehicle is plugged in and the charging needs of the EV's driver. The flexible capacity of a behind-the-meter battery depends on the owners' preferred minimum state of charge to preserve energy for emergencies (outages).

Electricity demand, dispatch, generation, load

Electricity **demand** refers to energy consumption — i.e., the flow of power to, and used by, a DER. Electricity **dispatch** refers to the controlled flow of power from a DER that either stores or *generates* electricity. Electricity **generation** that is not controlled (e.g., distributed solar or wind without storage) is not considered dispatchable. The term **electrical load** generally refers to the demand for electricity net of any locally supplied electricity from distributed generation or storage that reduce the amount of electricity the grid needs to provide from centralized assets.

Resource adequacy

Resource adequacy refers to the ability of the electric grid to satisfy the end-user power demand at any time; It is an assessment of whether the current or projected resource mix is sufficient to meet capacity and energy needs for a particular grid.

II. Illustrative 24-hour electrical load curve in 2024, 2030, 2050

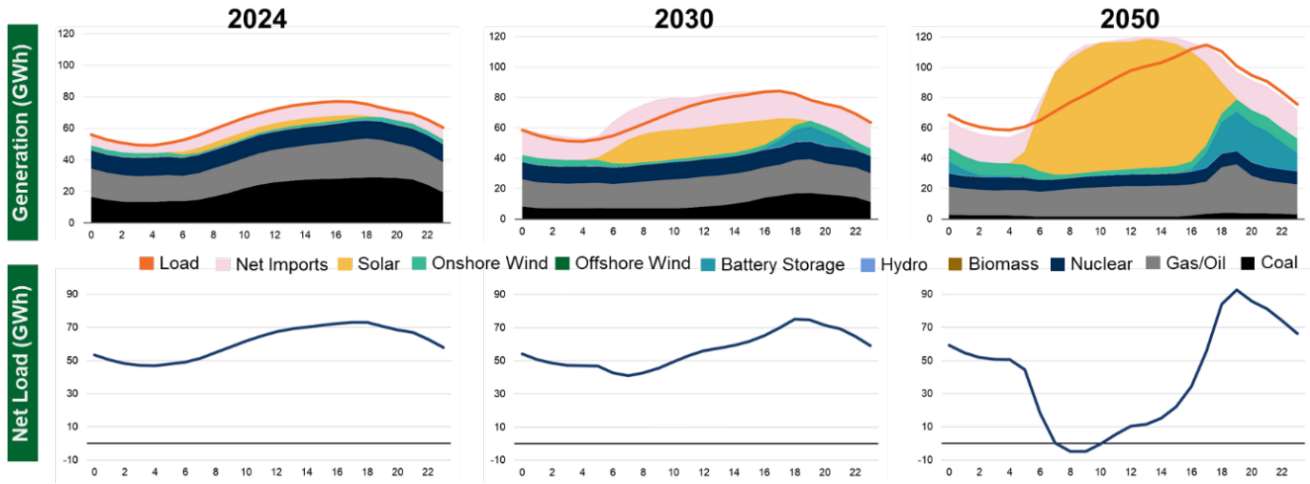

Note: “Net load” is the gross demand minus expected solar and wind generation. Profiles represent hourly averages for all summer days for a region in PJM under the Mid-Case scenario in NREL’s Cambium dataset. PJM represents a fossil dependent region that have a very different net load shape in later years with increased renewable deployment.

III. FERC definition of DER and DER Aggregator

FERC definition of DER: “Any resource located on the distribution system, any subsystem thereof or behind a customer meter. These resources may include, but are not limited to, resources that are in front of and behind the customer meter, electric storage resources, intermittent generation, distributed generation, demand response, energy efficiency, thermal storage, and EVs and their supply equipment.”

FERC definition of DER Aggregator: “The entity that aggregates one or more distributed energy resources for purposes of participation in the capacity, energy and/or ancillary service markets of the regional transmission organizations and/or independent system operators.”

IV. VPP Evolution

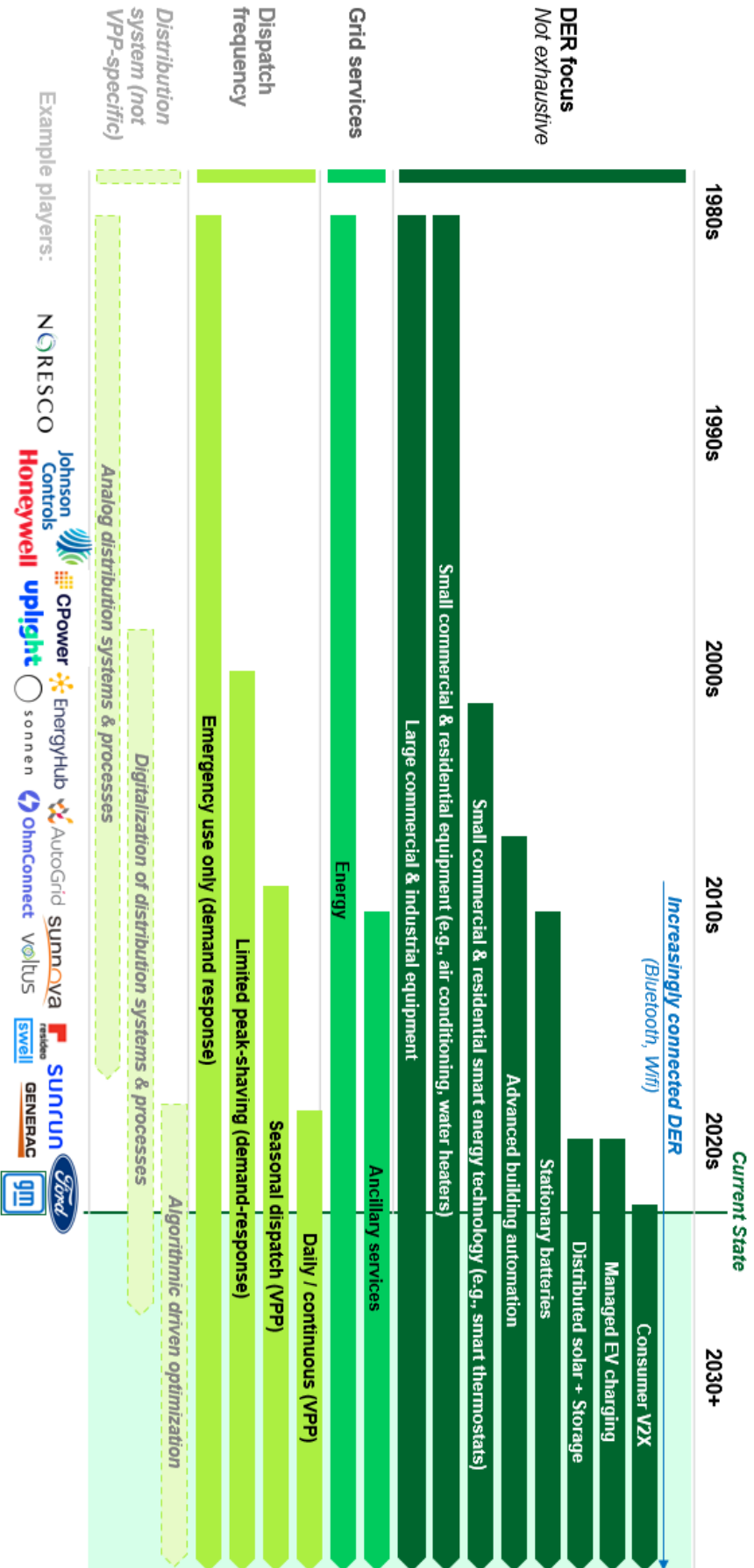

Source: Industry interviews, Company websites, Newport Consulting

V. Variation across VPPs

Dimension	Variables	Variants observed in-market (examples, not exhaustive)			
VPP archetypes	DERs	<ul style="list-style-type: none"> Water heaters Smart thermostats Appliances 	<ul style="list-style-type: none"> EV chargers Distributed solar with storage Commercial equipment 	<ul style="list-style-type: none"> EV battery storage Thermal storage Others 	
	DER functions	<ul style="list-style-type: none"> Demand (flexible to time-shift or shed) 	<ul style="list-style-type: none"> Storage 	<ul style="list-style-type: none"> Generation 	
	Market segment	<ul style="list-style-type: none"> Residential (single, multi-family) 	<ul style="list-style-type: none"> C&I (multiple sectors) 	<ul style="list-style-type: none"> Both 	
Organization structure	Participant-facing entity	<ul style="list-style-type: none"> 3rd party aggregator 	<ul style="list-style-type: none"> Utility 	<ul style="list-style-type: none"> OEM or retailer of DER 	
	VPP operator	<ul style="list-style-type: none"> 3rd party aggregator (branded or white-labeled) 	<ul style="list-style-type: none"> Utility (in-house) 	<ul style="list-style-type: none"> OEM or retailer of DER 	
	Sales channel	<ul style="list-style-type: none"> Wholesale markets (<i>Market participant VPP</i>) 	<ul style="list-style-type: none"> Retail utilities (<i>Retail VPP</i>) 	<ul style="list-style-type: none"> Other (e.g., carbon offset market) 	
Services sold	Services delivered / Revenue streams	<ul style="list-style-type: none"> Energy Capacity 	<ul style="list-style-type: none"> Ancillary services (e.g., freq., ramping) Deferred T&D infrastructure cost 	<ul style="list-style-type: none"> Emissions reduction Resilience benefits 	
	Dispatch frequency	<ul style="list-style-type: none"> Emergency only 	<ul style="list-style-type: none"> Seasonal 	<ul style="list-style-type: none"> (Up to) daily 	
	Demand-shaping vs. Exporting	<ul style="list-style-type: none"> <i>Demand-shaping</i>: DER demand is managed. Any stored or generated energy stays behind the meter for use on-site 	<ul style="list-style-type: none"> <i>Exporting</i>: Energy is dispatched from generation or storage DERs to grid 		
Participant incentives	Participation incentives	<ul style="list-style-type: none"> Payment upon sign-up Subsidy for DER 	<ul style="list-style-type: none"> Ongoing flat rate Event-based payment 	<ul style="list-style-type: none"> Payment per kW or kWh Other 	
	Incentive amount		<i>Varies by asset, market, and participation level</i>		
	Paid incentive channel	<ul style="list-style-type: none"> Off-bill 	<ul style="list-style-type: none"> On-bill 		
DER orchestration	DER control	<ul style="list-style-type: none"> VPP-initiated with customer override 	<ul style="list-style-type: none"> VPP-controlled w/o override (<i>not preferred</i>) 	<ul style="list-style-type: none"> Customer-controlled 	
	DER mgmt. timing	<ul style="list-style-type: none"> Dynamic responses to day-ahead, hour-ahead, or intra-hour grid signals 	<ul style="list-style-type: none"> Mostly scheduled, based on historical electricity patterns 	<ul style="list-style-type: none"> Passively incentivized 	
	DER mgmt. granularity	<ul style="list-style-type: none"> On/off 	<ul style="list-style-type: none"> Dial, optimized for DER owner comfort/convenience 		

VI. Enabling grid software and hardware technologies for VPPs

The table below contains examples of technologies that enable VPPs and a description of the typical role of the technology in VPPs. Not all VPPs require all technologies listed.

SOFTWARE		
Technology	Description	Role within a VPP
<i>Advanced Distribution Management System (ADMS)</i>	ADMS differentiate from traditional distribution management systems by providing next-generation control capabilities. This includes management of high penetrations of DERs, closed-loop interaction or control with connected DERs (including grid-interactive buildings), and integration with utility meter management systems, asset data, and billing systems. ADMS can be a software platform that supports the full suite of distribution management and optimization functions, including automation of functions like outage restoration.	ADMS are typically deployed by the entity responsible for the safe, efficient and reliable operation of the distribution grid (typically an electricity distribution utility or distribution system operator). ADMS can ensure the deployment and control of DERs, either individually or aggregated as a VPP, does not strain or violate operating requirements of distribution systems and does not cause local power quality issues. ADMS facilitate VPP participation in grid services through programs such as non-wires alternatives (NWA) and capital investment deferral. ADMS can also enable local capacity and power quality management.
<i>Distributed Energy Resource Management System (DERMS)</i>	DERMS are software-based solutions to monitor, forecast, and control grid-connected DERs across customer, grid, and/or market conditions in real-time. These assets may be utility, third-party, or customer-owned and directly or indirectly (such as through an aggregator) controlled by an off-taker, such as a utility.	In the context of VPPs, DERMS used by VPP operators act as the interface between the aggregation of DERs and the utility or off-taker. DERMS can also be an application that integrates with an ADMS. DERMS platforms forecast and optimize DER dispatch to maximize the value of the DERs. While ADMS ensures reliable and affordable electricity from <i>all</i> sources, DERMS contribute to electricity reliability and affordability from DER assets specifically. VPPs can operate without ADMS, but ADMS is important to enable large scale participation of VPPs in the operational management of power systems.
<i>Demand Response Management System (DRMS)</i>	DRMS are software-based solutions that include the administrative and business functions needed for demand response management. They coordinate key systems involved in demand response.	DRMS can be integrated with a DERMS controlling and coordinating VPPs to facilitate participation in demand response programs.
<i>Market Interfaces</i>	Market interfaces are a broad category of software platforms that facilitate the participation of assets in wholesale markets or load flexibility platforms.	Market interfaces allow VPPs to offer grid services without having to develop hardware and software integrations for every wholesale market or load flexibility program. They enable energy, capacity, demand response, and wholesale market participation.

HARDWARE		
Technology	Description	Role within a VPP
<i>Gateways</i>	Gateways are devices that facilitate communication and exchange of data and control signals between the load serving entity and FTM or BTM assets such as solar and storage.	Gateways assist in integration, communication, and dispatch of energy assets to provide services based on market and grid signals. In some applications, gateways may contain some of the logic used to dispatch on-site assets based on events or commands sent from a centralized DERMS platform. Gateways can also facilitate integration of assets where a DER equipment manufacturer or vendor has not provided their own cloud based platform, API, or compliance with a communication protocol that facilitates grid services.
<i>Advanced Metering Infrastructure (AMI)</i>	AMI, or 'smart meters,' are used to measure a customer's energy consumption during set time intervals. AMI includes technologies to measure and communicate energy use and other data and notifications at intervals that are granular enough to support grid and market operations. More advanced functions can include additional grid sensing functions.	<p>AMI can be used to measure and communicate the performance of individual sites participating in a VPP. Interval meter data from AMI is used in many VPPs as the basis for compensating participants.</p> <p>More advanced smart meters can act as grid sensors to support more complex use cases for VPPs. AMI may also provide real-time visibility into system load and can facilitate grid operators dispatching VPPs to support distribution system operation. AMI can also facilitate grid operators providing a dynamic or time-varying rate to customers to incentivize load flexibility.</p>
<i>Distributed solar</i>	Distributed solar, or distributed photovoltaics (PV), are solar energy resources that are deployed in close proximity to the end users of the power. This can include solar that is behind a customer meter, but also may include other models for deployment, such as community solar.	<p>Distributed solar can be aggregated within a VPP to provide capacity. When aggregated with other flexible demand DERs such as batteries, EV chargers, and connected devices, distributed solar can provide a source of carbon free energy.</p> <p>Solar is increasingly installed with "smart" or "grid support" inverters that are compliant with the IEEE 1547 technical standard for interconnecting distributed energy resources with electric power systems. The most recent revision, IEEE 1547-2018^{cvi}, helps facilitate communication between utilities and aggregators and DERs, and helps enable the secure exchange and use of information. IEEE 1547-2018 compliant inverters also have functions that can support grid reliability, such as reactive power absorption and production, that can be aggregated in a VPP as a grid service to provide additional revenue streams for VPP owners and operators.</p> <p>Grid services provided include: Energy, Reactive Power and Power Quality (with IEEE 1547-2018 compliant inverters), Resilience (when paired with energy storage).</p>

<p><i>Stationary Energy Storage (including, but not limited to, batteries)</i></p>	<p>Devices that can capture energy produced at one time for use at a later time, generally used to reduce imbalances between energy production and energy demand. Energy storage includes mechanical, electro-chemical, and thermal technologies. In general, only mechanical and electro-chemical technology can deliver electricity back to the grid/load (energy export) in DER applications.</p>	<p>Stationary energy storage systems can provide backup power for sites and assist in load shifting or grid services. Within VPPs, most batteries are paired with onsite generation (e.g., distributed solar), but may also be installed in standalone configurations. In either configuration, batteries can help increase site and grid resilience and reliability.</p> <p>Energy storage technologies provide a highly dispatchable resource for both capacity build and capacity reduce in a VPP and are well suited to provide ancillary services and participate in non-wires alternatives programs. Storage also helps firm intermittent renewables and allows VPPs to shift energy produced to be used at other times of day.</p> <p><i>Grid services provided include:</i> Energy, Capacity, Regulating Reserves, Reactive Power and Power Quality (with IEEE 1547-2018 compliant inverters), Frequency Response, Resilience.</p>
<p><i>Other Connected DERs</i></p>	<p>Other Connected (or grid-enabled) DERs are any individual technologies that connect at the customer site and typically downstream of a utility meter. These include discrete assets or loads that have enhancements to enable connectivity and control, either locally or by a remote third party. Examples of devices or appliances not discussed elsewhere in this table include commercial and residential refrigeration, advanced lighting controls, plug load controls, plug load controllers, clothes washers and dryers, and residential or commercial dishwashers.</p>	<p>Connected DERs are aggregated to build the total capacity that is available to be controlled as part of a VPP. Depending on the device, the connected DER can provide load flexibility at a variety of time scales. In VPPs with multiple asset types, the load flexibility of heterogenous assets can be stacked to participate in grid services across different time scales.</p>

VII. Potential grid services

The table below lists services that may be provided by DERs, today or in the future. It was primarily developed as a supporting reference document for the DOE's Operational Coordination and Integrated Distribution System Planning programs to facilitate applied research and industry discussions. This list includes services as may be applicable in the bulk power system, distribution system, and within the edge (e.g., customer and community). For additional information, including service-specific performance attributes and information sources, see DOE's *Bulk Power, Distribution & Edge Services Definitions*.

Bulk Power System	
<i>Energy</i>	The generation or use of electric power by a device over a period of time, expressed in kilowatt-hours (kWh), megawatt-hours (MWh), or gigawatt-hours (GWh) as transported across a transmission system.
<i>Regulating reserves</i>	Regulation Service provides for the management of the minute-to-minute differences between load and resources and to correct for unintended fluctuations in generator output to comply with NERC's Real-Power Balancing Control Performance Standards (BAL-001-1, BAL-001-2)
<i>Frequency response</i>	The ability of a system or elements of the system to react or respond to a change in system frequency for maintaining scheduled Interconnection frequency at sixty cycles per second (60 Hz).
<i>Inertial Response</i>	Inertial response injects stored kinetic or battery energy into the system, slowing down the decline in frequency to provide time for other reserve products (including primary frequency response (PFR), which is the next stage of reserve deployment) to detect those changes and respond accordingly.
<i>Primary Frequency Response (PFR)</i>	Automatic and autonomous response to frequency variations through a generator's droop parameter and governor response or energy injection by grid following inverters, or response by load.
<i>Fast Frequency Response (FFR)</i>	Fast frequency response combines characteristics of inertia and primary frequency response. It is essentially an energy injection that is provided almost immediately following a frequency deviation, that provides support by reducing the rate of change of frequency thereby increasing the minimum frequency, and reducing the steady-state frequency deviation due to a more continuous injection.
<i>Secondary Frequency Response</i>	To maintain grid frequency, and to honor scheduled energy flows between different Balancing Authorities (BA). It is measured through NERC Control Performance Standards (CPS1 and CPS2 – retired), and the new Balancing Authority Area Control Error Limit (BAAL) score requirements.
<i>Tertiary Frequency Response</i>	Maintain scheduled energy flows between different BAs, to maintain the BA generation-load balance (load-following reserve), or maintain grid reliability under N-1 contingencies (spinning and non-spinning reserve). Tertiary balancing service is provided by the spinning and non-spinning reserve units.
<i>Operating Reserves</i>	The active power capacity above firm system demand required to provide for regulation, load forecasting error, equipment forced and scheduled outages and local area protection. It consists of spinning and non-spinning reserve.
<i>Operating Reserves (Spinning)</i>	Spinning Reserve is the capability of resources synchronized to the system and fully available to serve load within the Disturbance Recovery Period following the contingency event; or Load fully removable from the system within the Disturbance Recovery Period following the contingency event.
<i>Operating Reserves (Non-Spinning)</i>	Non-spinning reserves are energy producing resources that that are off-line but that can respond to dispatch instructions.
<i>Operating Reserves (Tertiary)</i>	Tertiary or contingency reserve is used after Spinning and Non-spinning reserves are employed in the case of a contingency. It is procured to replace reserve capacity prior to a second contingency event to ensure operating reserves are restored to the required amount soon after the contingency.
<i>Reactive Power & Voltage Support</i>	The ability to control leading and lagging reactive power on the system to maintain appropriate voltage levels and acceptable voltage bandwidths, to maximize efficient transfer of real power to the load under normal and contingency conditions, and provide for operational flexibility under normal and abnormal conditions.

<i>Ramping</i>	The ability of a resource to ramp active power upward or downward in a certain amount of time. It is typically measured on a MW/min basis.
<i>Energy Imbalance</i>	Energy Imbalance Service is provided when a difference occurs between the scheduled and the actual delivery of energy to a load located within a Control Area over a single hour.
<i>Black Start</i>	The ability to energize a bus, meeting the Transmission Operator's restoration plan needs for Real and Reactive Power capability, frequency and voltage control, and that has been included in the Transmission Operator's restoration plan.
<i>Transmission Capacity</i>	A non-transmission alternative (NTA) supply and/or a load modifying service that provides as required via reduction or increase of power or load that is capable of reliably and consistently reducing net loading on desired transmission infrastructure.

Distribution System

<i>Distribution Voltage-Reactive Power</i>	The ability to control leading and lagging reactive power on the system to maintain appropriate voltage levels and acceptable voltage bandwidths (ANSI C84.1), to maximize efficient transfer of real power to the load under normal and contingency conditions, and provide for operational flexibility under normal and abnormal conditions.
<i>Power Quality</i>	Services that satisfy power quality requirements regarding flicker and harmonics should be within acceptable levels.
<i>Resilience</i>	Supply based services capable of improving local distribution resiliency and reliability within a microgrid. This service may also involve fast reconnection and availability of excess reserves to reduce demand when restoring customers abnormal configurations.
<i>Energy</i>	The production or use of electric power by a device over a period of time, expressed in kilowatt-hours (kWh), or megawatt-hours (MWh) as transported within a distribution system.

Edge

<i>Energy</i>	The production or use of electric current by a device over a period of time, expressed in kilowatt-hours (kWh) or megawatt-hours (MWh) as transported behind a metered grid connection point or behind a microgrid islanding point within a community microgrid boundary.
<i>Distribution Voltage-Reactive Power</i>	The ability to dynamically control leading and lagging reactive power on the distribution system to maintain appropriate voltage levels and acceptable voltage bandwidths (ANSI C84.1), to maximize efficient transfer of real power to the load under normal and contingency conditions.
<i>Power Quality</i>	Services that satisfy electric service power quality requirements, including flicker and harmonics within acceptable levels.
<i>Resilience</i>	Energy based service to supply connected net customer loads as determined by a typical load profile within the microgrid boundary during island mode when disconnected from the power grid at the islanding point.

VIII. Overview of VPP Business model cost and revenue drivers

The following schematic of VPP costs and revenues is simplified for instructive purposes.

Costs

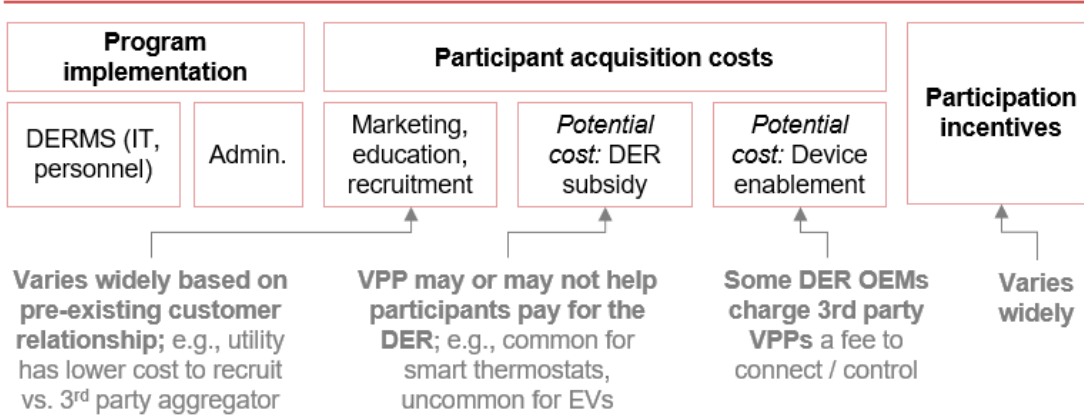

Revenues

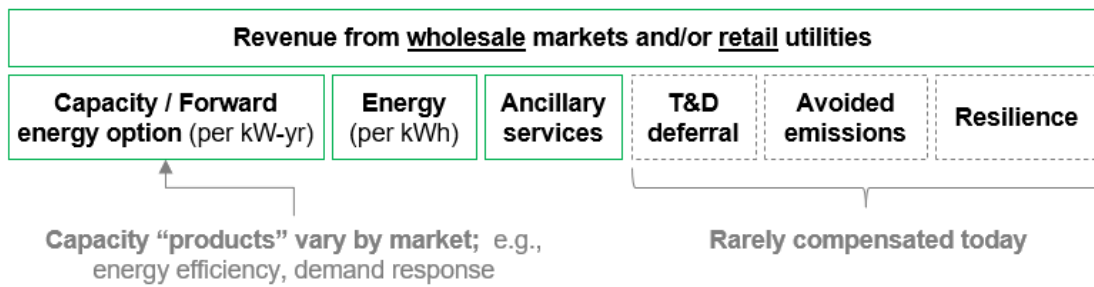

VPP SCALE

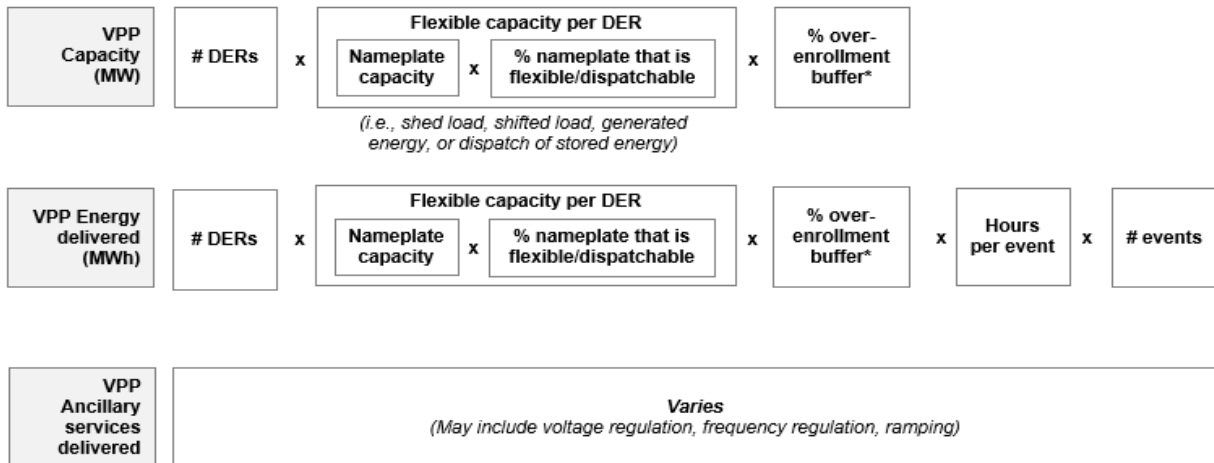

Note: *Over-enrollment buffer factor (>100%) accounts for the expectation that some enrolled DERs will not be dispatched when called upon.

IX. Cost and revenue detail for example smart thermostat demand response VPP

Variable Category	Variable	Description	Example: smart thermostat VPP	
Scale of VPP	# DERs	Number of distributed energy resources	100K thermostats	
	Flexible capacity per DER	Amount or percent of DER capacity that is flexible/controllable/dispatchable by VPP during an event (e.g., during peak demand hours)	1 kW per thermostat	
	Total flexible capacity	# DERs * Dispatchable capacity per DER	100 MW	
	Frequency of events	# of events per year	20 events; Summer	
	Total delivered energy (kWh)	Controllable capacity * % capacity activated in an event * Event duration * # of events	4000 MWh (2 hr duration per event)	
	Ancillary services	Services delivered per DER * # DERs activated per event * # of events	n/a	
Costs	System costs	IT system integration	DER<>VPP integration vary by DER; some OEMs charge integration fees to VPPs VPP<>off-taker integration costs may be incurred by 3rd-party VPPs selling to utilities or ISO/RTOs	\$500K (one-time; 5-yr lifetime)
		Hardware	Enabling non-DER hardware for distribution systems sometimes required (e.g., sensors, advanced metering infrastructure)	\$250K (one-time; 5-yr lifetime)
		Labor	Internal project management and consulting support to establish VPP	\$250K (one-time; 5-yr lifetime)
		Annual software costs	Software customization, annual licenses	\$650K per year
		Annual administrative costs	Program management, customer service, training, etc.	\$50K per year
		Total system costs per year	--	\$900K per year
	Customer costs	# Customers	--	100K
		One-time customer acquisition cost for marketing	Marketing costs and customer education	\$50 per customer;
		One-time customer acquisition cost for smart thermostat subsidy	DER hardware subsidy and/or installation	\$75 per customer; (includes \$50 per thermostat)
		Total customer acquisition costs (amortized over 5-yr customer lifetime)	--	\$2.5M per year
		Average activation incentive	Varies based on DER type, business model, event timing, and urgency of local grid conditions; In some cases, a flat rate is paid instead of a variable rate	\$3 per event (\$1.5 per kWh)
Activation costs per year		Incentive * # customers activated per event * # events	\$6M per year	
Total customer costs per year		--	\$8.5M per year	
Total costs per yr	--	\$9.4M per year		
Value	Monetized value	Energy (kWh)	Energy sold to, or procured by, ISOs/RTOs or utilities at market prices (per kWh)	\$400K (~\$100 per MWh in summer months)
		Capacity (kW)	Capacity sold to, or procured by, ISOs/RTOs or utilities at market prices (per kW)	\$8M-\$10M (\$80-100 per kW-yr)
		Ancillary Services	E.g., frequency regulation, ramping, etc.	n/a
	Additional value	Deferred T&D infrastructure costs	<i>Not consistently compensated</i>	varies
		Avoided cost of carbon	<i>Not consistently compensated</i>	varies
		Reliability benefits	<i>Not consistently compensated</i>	varies
		Total revenue per year	--	\$8.4M-\$10.4M

X. 2030 flexible demand capacity and grid savings potential detail

Data shown below is the result of analysis completed by Hledik and Peters of The Brattle Group in 2023 for the VPP Liftoff report. It is a refresh of, The National Potential for Load Flexibility (2019)^{cix} with up-to-date market assumptions (e.g., DER adoption, mix of renewables in the bulk power system, load profiles). The national cost-effective, achievable potential for the demand flexibility options considered in Brattle’s analysis is 180 GW. This estimate is slightly lower than potential measured in The Brattle Group’s 2019 study (198 GW) because:

- Higher assumed penetration of solar shifts system net peak demand later in the day. This evening peak is less coincident with large C&I peak demand, which is a significant source of demand flexibility potential.
- The hourly marginal energy costs used in the updated analysis have less overall price variation, due in part to differences in gas price outlook.

National potential for cost-effective flexible demand capacity in 2030 (GW)

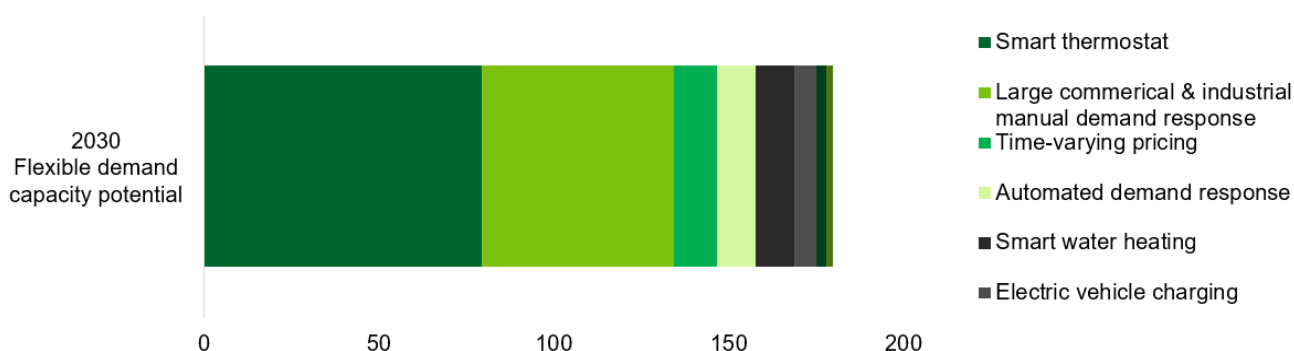

Load control strategies:

- **Smart Thermostat:** An alternative to conventional air conditioner direct-load-control, smart thermostats allow the temperature set point to be remotely controlled to reduce air conditioner or heating usage during peak times.
- **Large Commercial and Industrial Manual Demand Response:** Participants agree to reduce demand to a pre-specified level and receive an incentive payment in the form of a discounted rate.
- **Time-varying Pricing⁷²:** Time-of-use or critical peak pricing rates are used to incentivize behavioral price response through peak/off-peak price differentials. Portfolio potential estimates account for and avoid double-counting potential with EV time-of-use management.
- **Auto-Demand Response:** Auto-Demand Response technology automates the control of various commercial and industrial end-uses. Features of the technology allow for deep curtailment during peak events, moderate demand shifting on a daily basis, and demand increases and decreases to provide ancillary services. Modeled end-uses include heating, lighting, and heating, ventilation, and air conditioning.
- **Smart Water Heating:** Smart control offers improved flexibility and functionality in the control of the heating element in the water heater. The thermostat can be modulated across a range of temperatures. Multiple demand control strategies are possible, such as peak shaving, energy price arbitrage through day/night thermal storage, or the provision of ancillary services such as frequency

⁷² Time-of-use pricing is not a VPP, but is included in this analysis to demonstrate flexible demand potential. Although this load control strategy shares characteristics with a VPP—i.e., using a large number of DERs to shape demand profiles—it lacks a unifying architecture that allows the DER aggregation to interact with a grid operator as one utility-scale resource.

regulation. We modeled the control of electric resistance water heaters, as these represent the vast majority of electric water heaters and are currently the most attractive candidates for a range of advanced demand control strategies.

- **EV Charging:** Time-of-use rates* are an effective tool for encouraging off-peak charging of EVs at home, with early evidence indicating that 70% or more of the peak period charging demand of participants could be shifted to off-peak hours.
 - ▶ Includes only unidirectional charging; excludes vehicle-to-everything (V2X).
 - ▶ Home charging only; excludes commercial fleets.
 - ▶ Demand management potential is associated with a distribution system that does not yet face capacity constraints; constraints would lead to greater use of direct management of EV charging (vs. time-of-use).
- **Air Conditioner Direct-Load-Control:** Participant’s central air conditioner is remotely cycled using a switch on the compressor.
- **Demand Bidding:** Participants submit hourly curtailment schedules on a daily basis and, if the bids are accepted, must curtail the bid amount to receive the incentive payment or may be subject to a non-compliance penalty.

Savings potential from managing national cost-effective flexible demand capacity in 2030, \$B

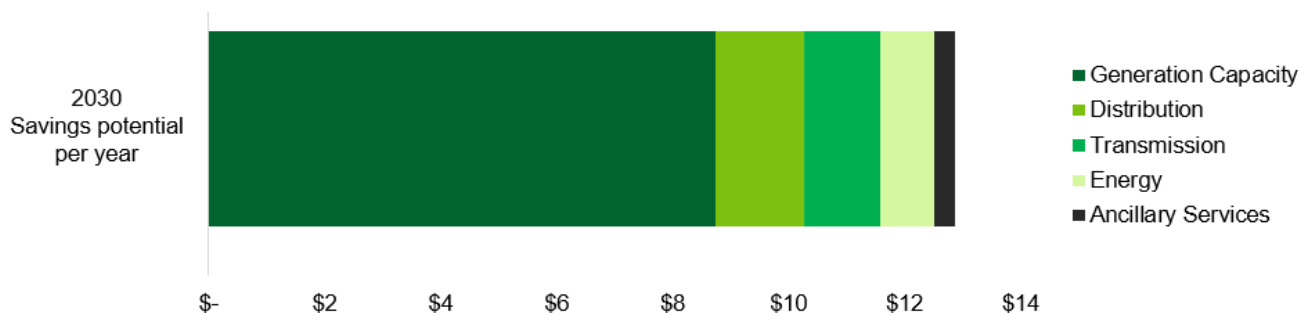

The gross benefits (avoided resource costs) of the demand flexibility potential are nearly \$13 billion per year by 2030. These benefits are net of the costs of obtaining the demand flexibility, though all programs included in the results are cost-effective.

Avoided Generation Capacity (est. \$8.75B)

- Value based on net cost of new entry in wholesale capacity markets.
- Capacity remains the dominant source of demand flexibility value through at least 2030.
- Capacity value will vary significantly by region; demand flexibility poised to provide most capacity value in regions with pending capacity retirements, supply needs in transmission-constrained locations, or unexpected supply shortages.

Avoided Energy Costs (est. \$0.94B)

- Value accounts for reduced resource costs associated with shifting demand to hours with lower cost to serve; does not include consumer benefits from reductions in wholesale price of electricity
- Energy value is best captured through programs that provide daily flexibility year-round, such as Auto-Demand Response for commercial and industrial customers, time-of-use rates, EV charging demand control, and smart water heating.

Avoided Transmission & Distribution Capacity (est. \$2.83B)

- Value represents system-wide benefits of peak demand reduction and is based on review avoided costs assumed in utility studies in a variety of U.S. jurisdictions. This value will vary significantly by system and location.

Ancillary Services (est. \$0.35B)

- Value accounts only for frequency regulation and assumes a need equal to 0.5% of system peak demand; additional value may exist if considering other ancillary services products.
- Frequency regulation provides very high value to a small amount of capacity; in our analysis, the full need for frequency regulation can be served through a robust smart water heating program.

XI. Modeling tools available from select DOE-partnered national laboratories

The table below contains examples of data and modeling resources developed by DOE-partnered national laboratories that support VPP deployment.

Resource	Use case	Target user	Description
dsgrid: Demand-Side Grid Toolkit (NREL)	Customer load prediction	Utilities, DER aggregators	Dsgrid creates comprehensive electricity load data sets at high temporal, geographic, sectoral, and end-use resolution. These data sets enable detailed analyses of current patterns and future projections of end-use loads.
dGen (NREL)	Customer DER adoption prediction	Utilities, DER aggregators	The Distributed Generation Market Demand model simulates customer adoption of distributed energy resources for residential, commercial, and industrial entities through 2050.
DER-CAM (Berkeley)	DER investment planning	Industrial-scale consumers	The Distributed Energy Resources Customer Adoption Model (DER-CAM) is a decision support tool that finds the optimal DER investment in the context of buildings or multi-energy microgrids. It can be used to find the optimal portfolio, sizing, placement, and dispatch of a wide range of DER, while co-optimizing multiple stacked value streams that include load shifting, peak shaving, power export agreements, or participation in ancillary service markets.
Cambium (NREL)	Grid operations and maintenance planning	Utilities	Cambium data sets contain modeled hourly emission, cost, and operational data for a range of possible futures of the U.S. electricity sector through 2050, with metrics designed to be useful for forward-looking analysis and decision support.

<p>Integrated Modeling Tool (Berkeley)</p>	<p>Grid operations and maintenance planning</p>	<p>Utilities, regulators</p>	<p>The Integrated Modeling Tool provides quantitative information to utilities and regulators to help them manage changing grid hosting capacity costs as consumers adopt DERs.</p>
<p>Distributed Optimal and Predictive Energy Resources (Berkeley)</p>	<p>Real-time DER management & optimization</p>	<p>DER aggregators</p>	<p>The DOPER is an open-source model predictive controller for distributed energy resources. It optimally coordinates DERs, such as distributed solar with smart inverters, battery storage, and EVs, as well as building components such as lighting, HVAC, and controllable loads. The objective is to minimize the total energy cost, peak demand, and/or greenhouse gas emissions for a single/multiple sites or whole distribution grid levels. DOPER also includes ancillary service market models, such as frequency regulation and demand bidding programs, to provide additional services to the grid while reducing energy costs.</p>
<p>GRIDMeter (Berkeley)</p>	<p>Real-time DER management & optimization</p>	<p>Utilities, DER aggregators</p>	<p>GRIDmeter is a combination of methods and open-source coding that enable accurate measurement of behind-the-meter DER impacts for commercial and residential buildings by identifying comparison groups via stratified sampling on key usage parameters to enable a high level of accuracy and confidence in behind-the-meter resources.</p>
<p>Time Sensitive Value Calculator (Berkeley)</p>	<p>Real-time DER management & optimization</p>	<p>Utilities, DER aggregators</p>	<p>The Time Sensitive Value Calculator is an Excel-based tool that estimates the value of energy efficiency and DER measures using hourly estimates of electricity system costs. The Calculator takes hourly profiles of up to six measures at a time and monetizes their value for six value streams, producing outputs in tabular and graphical formats.</p>
<p>REopt: Renewable Energy Integration & Optimization (NREL)</p>	<p>Real-time DER management & optimization</p>	<p>DER aggregators</p>	<p>The REopt™ model provides concurrent, multiple technology integration and optimization capabilities to help organizations meet their cost savings and energy performance goals. The REopt model recommends an optimally sized mix of renewable energy, conventional generation, and energy storage technologies; estimates the net present value of implementing those technologies; and provides a dispatch strategy for operating the technology mix at maximum economic efficiency.</p>

OptGrid Controls (NREL)	Real-time DER management & optimization	DER aggregators	OptGrid solves real-time optimal power flow problems at the grid edge, where it is installed on common devices like smart meters and inverters. OptGrid coordinates the optimized devices so that collectively, DERs are used to balance supply and demand, support grid reliability, and reduce the impact of outage events.
LODGE <i>[To be released in late 2023]</i> (Berkeley)	DER investment planning; distribution grid capacity expansion	Utilities	The Least-cost Optimal Distribution Grid Expansion (LODGE) model is a deterministic capacity expansion and planning model for distribution grids. Based on the REPAIR model , LODGE allows for automated upgrade analysis of hundreds or potentially thousands of distribution circuits or feeders. The model finds the least-cost portfolio of traditional distribution system upgrades to integrate community-scale solar generation in combination with alternative solutions, such as utility-owned storage

XII. Recommendations for further analysis

Valuable extensions of this first VPP liftoff report would include deeper analysis of specific types of VPPs:

- Adoption readiness level (ARL) and technology readiness level (TRL) assessments, for example in residential vehicle-to-grid VPPs that has seen limited deployment in the U.S..
- DER-specific value chain analysis, including a deeper focus on workforce implications.
- Comparative analysis of different VPP business models and their impact on consumers and grid integrity, and potential policy implications for how flexible electricity demand is managed and controlled across stakeholders (i.e., utilities, VPP platforms, DER manufacturers, etc.)
- Detailed analysis of challenges and potential solutions that are specific to the VPP type and/or the underlying DERs.

In addition, market readiness analysis based on criteria outlined in chapter 5, 'leading indicators' can inform roadmaps for VPP deployment.

References

- i. Office of Policy – National Energy Modeling System. 2023. Advanced BIL-IRA Scenario
- ii. Denholm, Paul, Patrick Brown, Wesley Cole, et al. 2022. *Examining Supply-Side Options to Achieve 100% Clean Electricity by 2035*. National Renewable Energy Laboratory. <https://www.nrel.gov/docs/fy22osti/81644.pdf>
- iii. Rand, J., Wiser, R., Robson, D., Jeong, S., Kemp, J. M., Seel, J., Gorman, W., & Strauss, R. April 2023. *Queued Up: Characteristics of Power Plants Seeking Transmission Interconnection As of the End of 2022*. https://etapublications.lbl.gov/sites/default/files/queued_up_may_2021.pdf
- iv. Wolfe, M. April 2023. *End of Winter Energy*. National Energy Assistance Directors' Association. <https://neada.org/press-release-neada-releases-end-of-winter-energy-update/>
- v. Hledik, R., & Peters, K. May 2023. *Real reliability: The value of virtual power: The Brattle Group*. https://www.brattle.com/wp-content/uploads/2023/04/Real-Reliability-The-Value-of-Virtual-Power_5.3.2023.pdf
- vi. Alternative Fuels Data Center. N.d. *Developing Infrastructure to Charge Electric Vehicles*. U.S. Department of Energy. https://afdc.energy.gov/fuels/electricity_infrastructure.html
- vii. National Renewable Energy Laboratory. June 2023. *The 2030 National Charging Network: Estimating U.S. Light-Duty Demand for Electric Vehicle Charging Infrastructure*. National Renewable Energy Labs
- viii. Office of Policy – National Energy Modeling System. 2023. *Advanced BIL-IRA Scenario*.
- ix. Wood Mackenzie. Dec. 2021. *United States Distributed Energy Resources Outlook*. Wood Mackenzie.
- x. Ibid.
- xi. National Renewable Energy Laboratory. 2022. *Metric definitions and scenario descriptions: 2022 Standard Scenarios Report*. National Renewable Energy Laboratory. <https://www.nrel.gov/docs/fy23osti/84327.pdf>
- xii. BloombergNEF. 2023. *Annual U.S. Wind, Solar, and Storage Capacity Additions*. BloombergNEF.
- xiii. Federal Energy Management Program. N.d. *Managed electric vehicle charging*. U.S. Department of Energy. <https://www.energy.gov/femp/managed-electric-vehicle-charging>
- xiv. NASEO. N.d. NASEO-NARUC Grid-Interactive Efficient Buildings Working Group. NASEO. <https://www.naseo.org/issues/buildings/naseo-naruc-geb-working-group>
- xv. Denholm, Paul, Patrick Brown, Wesley Cole, et al. 2022. *Examining Supply-Side Options to Achieve 100% Clean Electricity by 2035*. National Renewable Energy Laboratory. <https://www.nrel.gov/docs/fy22osti/81644.pdf>
- xvi. Rand, J., Wiser, R., Robson, D., Jeong, S., Kemp, J. M., Seel, J., Gorman, W., & Strauss, R. April 2023. *Queued Up: Characteristics of Power Plants Seeking Transmission Interconnection As of the End of 2022*. Laurence Berkeley National Lab. https://etapublications.lbl.gov/sites/default/files/queued_up_may_2021.pdf
- xvii. Wolfe, M. April 2023. *End of Winter Energy*. <https://neada.org/wp-content/uploads/2023/04/eowapril2023.pdf>. National Energy Assistance Directors' Association. <https://neada.org/wp-content/uploads/2023/04/eowapril2023.pdf>
- xviii. Hledik, R., & Peters, K. May 2023. *Real reliability: The value of virtual power: The Brattle Group*. https://www.brattle.com/wp-content/uploads/2023/04/Real-Reliability-The-Value-of-Virtual-Power_5.3.2023.pdf
- xix. California Public Utilities Commission. 2018. *Decision on Southern California Edison Company's General Rate Case Application for 2018-2020*. California Public Utilities Commission. <https://docs.cpuc.ca.gov/PublishedDocs/Efile/G000/M508/K423/508423247.PDF>
- xx. California Public Utilities Commission. June 5, 2023. *Public Advocates Office study on the costs of upgrading the distribution grid for electrification*. California Public Utilities Commission. <https://www.publicadvocates.cpuc.ca.gov/-/media/cal-advocates-website/files/reports/230605-cal-advocates-distribution-grid-impacts-study.pdf>
- xxi. Nadel, F., Amann, J., Chen, H. May 2023. *Energy Efficiency and Demand Response: Tools to Address Texas' Reliability Challenges: Summary*. ACEEE https://www.aceee.org/sites/default/files/pdfs/b2302_-_en-crypt_1_1.pdf
- xxii. Venkataraman, S., Speckman, B. May 2022, *Transportation Electrification Distribution System Impact Study*. NYSERDA.
- xxiii. U.S. Department of Energy. May 2018. *DOE-417: Electric Disturbance Events*. U.S. Department of Energy. <https://www.oe.netl.doe.gov/oe417.aspx>
- xxiv. NERC. 2019. *Level 3 Alert: Essential Actions to Industry Cold Weather Preparations for Extreme Weather Events III*. NERC. <https://www.nerc.com/pa/rrm/bpsa/Alerts%20DL/Level%203%20Alert%20Essential%20Actions%20to%20Industry%20Cold%20Weather%20Preparations%20for%20Extreme%20Weather%20Events%20III.pdf>
- xxv. Strategen. July 2022. *Peaker problem & CEG*. Strategen. <https://www.strategen.com/strategen-blog/peaker-problem-ceg>
- xxvi. U.S. Department of Energy. February 24, 2023. *National Transmission Need Study, U.S. Department of Energy*. <https://www.energy.gov/sites/default/files/2023-02/022423-DRAFTNeedsStudyforPublicComment.pdf>
- xxvii. Rand, J., Wiser, R., Robson, D., Jeong, S., Kemp, J. M., Seel, J., Gorman, W., & Strauss, R. April 2023. *Queued Up: Characteristics of Power Plants Seeking Transmission Interconnection As of the End of 2022*. Laurence Berkeley National Lab. https://etapublications.lbl.gov/sites/default/files/queued_up_may_2021.pdf
- xxviii. *SCE Electric Vehicle (EV) Virtual Power Plant Analysis Shows \$5,600 10-Year Savings Per EV Customer*. Southern California Electric Vehicle Virtual Power Plant. (2019, October 16). https://maisy.com/SCE_EV_Virtual_Power_Plant.pdf
- xxix. California State Legislature. February 12, 2023. *Electricity: optional flexible interconnection tariff: onsite demand and distributed energy resources*. AB-691, California State Legislature. https://leginfo.ca.gov/faces/billNavClient.xhtml?bill_id=20230240AB691
- xxx. Nimiipuu Energy. N.d. Nimiipuu Energy. Nimiipuu Energy. <https://www.nimiipuu.energy/>
- xxxi. U.S. Department of Labor. *The Good Jobs Initiative*. <https://www.dol.gov/general/good-jobs/principles>
- xxxii. U.S. Energy Information Administration. February 2023. *Electric Monthly Update Highlights: December 2022*. U.S. Energy Information Administration. <https://www.eia.gov/electricity/monthly/update/archive/february2023/>
- xxxiii. Organization of MISO States. 2022. *OMS-MISO Survey Results*. Organization of MISO States. <https://cdn.misoenergy.org/20220610%20OMS-MISO%20Survey%20Results%20Workshop%20Presentation625148.pdf>
- xxxiv. North American Electric Reliability Corporation. May 2022. *2022 Summer Reliability Assessment*. Retrieved from https://www.nerc.com/pa/RAPA/ra/Reliability%20Assessments%20DL/NERC_SRA_2022.pdf
- xxxv. City of New York. 2021. *Local Laws of the City of New York for the Year 2021 no. 154*. City of New York. https://www.nyc.gov/assets/buildings/local_laws/1154of2021.pdf
- xxxvi. New York State Climate Action Council (December 2022). *New York State Climate Action Council Scoping Plan*. [Climate.ny.gov/ScopingPlan](https://climate.ny.gov/ScopingPlan)
- xxxvii. Wood Mackenzie. 2019. *North America Virtual Power Plant (VPP) Market H1 2023*. Wood Mackenzie. <https://www.woodmac.com/reports/power-markets-north-america-virtual-power-plant-vpp-market-h1-2023-150103190/>
- xxxviii. Federal Energy Regulatory Commission. December 2022. *Assessment of Demand Response and Advanced Metering*. Federal Energy Regulatory Commission.
- xxxix. Alternative Fuels Data Center. N.d. *Developing Infrastructure to Charge Electric Vehicles*. U.S. Department of Energy. https://afdc.energy.gov/fuels/electricity_infrastructure.html
- xl. National Renewable Energy Laboratory. June 2023. *The 2030 National Charging Network: Estimating U.S. Light-Duty Demand for Electric Vehicle Charging Infrastructure*. National Renewable Energy Labs

- xli. Office of Policy – National Energy Modeling System. 2023. *Advanced BIL-IRA Scenario*.
- xlii. Wood Mackenzie. Dec. 2021. *United States Distributed Energy Resources Outlook*. Wood Mackenzie.
- xliii. Ibid.
- xliv. National Renewable Energy Laboratory. 2022. *Metric definitions and scenario descriptions: 2022 Standard Scenarios Report*. <https://www.nrel.gov/docs/fy23osti/84327.pdf>
- xlv. BloombergNEF. 2023. *Annual U.S. Wind, Solar, and Storage Capacity Additions*. BloombergNEF.
- xlvi. CPUC. June 2020. *Final Report of the California Joint Agencies Vehicle-Grid Integration Working Group*. CPUC. <https://gridworks.org/wp-content/uploads/2020/07/VGI-Working-Group-Final-Report-6.30.20.pdf>
- xlvii. Vehicle Technologies Office. 2022. *2022 Incremental Purchase Cost Methodology and Results for Clean Vehicles*. U.S. Department of Energy.
- xlviii. National Renewable Energy Labs. June 2023. *The 2030 National Charging Network: Estimating U.S. Light-Duty Demand for Electric Vehicle Charging Infrastructure*. National Renewable Energy Labs. <https://driveelectric.gov/files/2030-charging-network.pdf>
- xlix. Ibid.
- i. Lawrence Berkeley National Labs. 2022. *Tracking the Sun: Pricing and Design Trends for Distributed Photovoltaic Systems in the United States*. Lawrence Berkeley National Labs https://emp.lbl.gov/sites/default/files/2_tracking_the_sun_2022_report.pdf
- ii. Industry interviews.
- iii. Wood Mackenzie. December 2021. *United States Distributed Energy Resources Outlook*. Wood Mackenzie.
- liii. Wood Mackenzie. 2019. *North America Virtual Power Plant (VPP) Market H1 2023*. Wood Mackenzie. <https://www.woodmac.com/reports/power-markets-north-america-virtual-power-plant-vpp-market-h1-2023-150103190/>
- liv. National Grid. N.d. Demand Response Program. National Grid. <https://www.nationalgridus.com/connectedsolutions>
- lv. Industry interviews.
- lvi. *NHEC Load Management Developments Report*. November 1, 2003.
- lvii. CAISO. November 2, 2022. *Summer Market Performance Report*. CAISO. <http://www.caiso.com/Documents/SummerMarketPerformanceReport-forSeptember2022.pdf>
- lviii. FERC, *2022 Assessment of Demand Response and Advanced Metering*
- lix. Rocky Mountain Institute. 2018. *Virtual power plants: Real benefits*. Rocky Mountain Institute. <https://rmi.org/insight/virtual-power-plants-real-benefits/>
- lx. Ibid.
- lxi. Wood Mackenzie. 2019. *North America Virtual Power Plant (VPP) Market H1 2023*. Wood Mackenzie. <https://www.woodmac.com/reports/power-markets-north-america-virtual-power-plant-vpp-market-h1-2023-150103190/>
- lxii. California ISO. <https://www.caiso.com/Pages/default.aspx>
- lxiii. Electric Reliability Council of Texas. <https://www.ercot.com/>
- lxiv. New York Independent System Operator. <https://www.nyiso.com/>
- lxv. EPRI. 2022. *Wholesale Electricity Market Design in North America: 2021 Review*. EPRI.
- lxvi. CAISO. August 2023. *Summary of Restricted Maintenance Operations, Flex Alerts, Transmission and Energy Emergencies Issued from May 2022 to Present*. CAISO. <https://www.caiso.com/Documents/Grid-Emergencies-History-Report-1998-Present.pdf>
- lxvii. Lin, N., Kutanoglu, E., Leibowicz, B., Niyongi, D., Rai, V., Santoso, S., Spence, D., Tompaldis, S., Zhu, H., Funkhouser, E. Austgen, B. *July 2021 The Timeline and Events of the February 2021 Texas Electric Grid Blackouts*, The University of Texas at Austin Energy Institute. <https://energy.utexas.edu/sites/default/files/UTAustin%20%282021%29%20EventsFebruary2021TexasBlackout%2020210714.pdf>
- lxviii. Sunrun. February 17, 2019. *Sunrun Activates Nation's First Residential Virtual Power Plant in California*. Sunrun. <https://investors.sunrun.com/news-events/press-releases/detail/273/sunrun-activates-nations-first-residential-virtual-power>
- lxix. U.S. Department of Energy. December 11, 2019. *Heat pump water heaters achieve significant peak reduction and energy savings*. U.S. Department of Energy. <https://www.energy.gov/eere/buildings/articles/heat-pump-water-heaters-achieve-significant-peak-reduction-and-energy>
- lxx. Octopus Energy. 2023. *EV Energy Plan*. Octopus Energy.
- lxxi. Fermata Energy. September 8, 2022. *Firstlight power, Fermata Energy, and Skyview Ventures Partner to launch first ever vehicle-to-grid charging platform in Western Massachusetts*. Fermata Energy. <https://fermataenergy.com/article/firstlight-power-fermata-energy-and-skyview-ventures>
- lxxii. Duke Energy. August 16, 2022. *Illuminating possibility: Duke energy and Ford Motor Company plan to use F-150 lightning electric trucks to help power the grid*. Duke Energy. <https://news.duke-energy.com/releases/illuminating-possibility-duke-energy-and-ford-motor-company-plan-to-use-f-150-lightning-electric-trucks-to-help-power-the-grid>
- lxxiii. Clack, C.T.M., Choukular, A., Coté, B. McKee, S.A. October 7, 2021. *A Plan for Economy-Wide Decarbonization of the United States*. Vibrant Clean Energy, LLC.
- lxxiv. National Renewable Energy Laboratory. *Annual Technology Baseline 2022*. https://atb.nrel.gov/electricity/2022/fossil_energy_technologies
- lxxv. Idaho National Laboratory. July 21, 2023. *New Tech Brings Resilience to Small-Town Hydropower*. Idaho National Laboratory. <https://inl.gov/water-power/new-tech-brings-resilience-to-small-town-hydropower/>
- lxxvi. Clack, C.T.M., Choukular, A., Coté, B. McKee, S.A. October 7, 2021. *A Plan for Economy-Wide Decarbonization of the United States*. Vibrant Clean Energy, LLC.
- lxxvii. Industry Interviews.
- lxxviii. U.S. Department of Labor. *Occupations with the smallest share of women workers*. <https://www.dol.gov/agencies/wb/data/occupations/occupations-smallest-share-women-workers>
- lxxix. Ibid.
- lxxx. Speetles, B., Cui, B., Lockhart, E., & Warren, A. February 10, 2023. *Virtual Power Plants and Environmental and Energy Justice*. NREL.
- lxxxi. Arciniegas, L., & Hittinger, E. 2018. *Tradeoffs between revenue and emissions in energy storage operation*. Energy, 143. <https://doi.org/https://www.sciencedirect.com/science/article/pii/S0360544217318145#abs0015>
- lxxxii. Zheng, J., Lin, Z.-E., Masanet, E., Deshmukh, R., & Suh, S. 2021. *Lifecycle cost and carbon implications of residential solar-plus-storage in California*. iScience, 24(12). <https://doi.org/10.1016/j.isci.2021.103492>
- lxxxiii. *Advanced Water Heating Initiative 2023, About Heat Pump Water Heaters*. <https://www.advancedwaterheatinginitiative.org/about-heat-pump-water-heaters>
- lxxxiv. U.S. Energy Information Administration. N.d. *Homes and buildings in the west and northeast have the largest share of small-scale solar*. U.S. Energy Information Administration. <https://www.eia.gov/todayinenergy/detail.php?id=54379>
- lxxxv. Kozak, Blake. 2022. *Smart Home Dynamics Report – 2021*. Omidia.
- lxxxvi. Deason, J., Leventis, G., & Murphy, S. May 2021. *Performance of solar leasing for low- and middle-income customers in Connecticut*. Laurence Berkeley National Labs. <https://emp.lbl.gov/publications/performance-solar-leasing-low-and>
- lxxxvii. Zimring, M., Leventis, G., Borgeson, M., Thompson, P., Hoffman, I., Goldman, L. 2014. *Financing Energy Improvements on Utility Bills: Market Updates and Key Program Design Considerations for Policymakers and Administrators*. Lawrence Berkeley National Labs.
- lxxxviii. Deason, J., Leventis, G., & Murphy, S. March 2022. *Long-Term Performance of Energy Efficiency Loan Portfolios*. Laurence Berkeley National Labs. <https://emp.lbl.gov/publications/long-term-performance-energy>
- lxxxix. NYSERDA. 2020. *NYStretch Energy Code: 2020 Outreach, Training and Resources*. NYSERDA. <https://www.nysersda.ny.gov/All-Programs/Clean-Resilient-Building-Codes/NYStretch-Energy-Code-2020>
- xc. National Renewable Energy Laboratory. February 2029. *Community Choice Aggregation: Challenges, Opportunities, and Impacts on Renewable Energy Markets*. National Renewable Energy Laboratory. <https://www.nrel.gov/docs/fy19osti/72195.pdf>
- xc. Uplight. 2021. *Consumers Energy Provides 100,000 Pre-Enrolled Smart Thermostats to Save Money and Energy*. Uplight. <https://uplight.com/>

- [wp-content/uploads/2021/03/U_CaseStudy_ConsumersEnergy_Thermostat_2021.pdf](#)
- xcii. Energy Star. N.d. *Connected criteria for partners*. https://www.energystar.gov/products/smart_home_tips/about_products_connected_functionality/connected_criteria_partners
- xciii. CEE. 2021. *CEE Program Resources*. CEE. <https://cee1.org/content/cee-program-resources>
- xciv. Glass, J., Suffian, S., Scheer, A., Best, C. February 2022. *Demand Response Advanced Measurement Methodology: Analysis of Open-Source Baseline and Comparison Group Methods to Enable CAISO Demand Response Resource Performance Evaluation*. CAISO. http://www.caiso.com/Documents/Demand-Response_Advanced_Measurement_Methodology_updated_Feb_2022.pdf
- xcv. Gopstein, A., Nguyen, C., O'Fallon, C., Wollman, D., & Hasting, N. February 2021. *NIST Framework and Roadmap for Smart Grid Interoperability Standards, Release 4.0*. National Institute of Standards and Technology. <https://nvlpubs.nist.gov/nistpubs/SpecialPublications/NIST.SP.1108r4.pdf>
- xcvi. The White House. March, 2023. *National Cybersecurity Strategy*. The White House. <https://www.whitehouse.gov/wp-content/uploads/2023/03/National-Cybersecurity-Strategy-2023.pdf>
- xcvii. U.S. Department of Energy. June 2022. *National Cyber-Informed Engineering Strategy*. U.S. Department of Energy. https://www.energy.gov/sites/default/files/2022-06/FINAL%20DOE%20National%20CIE%20Strategy%20-%20June%202022_0.pdf
- xcviii. U.S. Department of Energy. October 2022. *Cybersecurity Considerations for Distributed Energy Resources on the U.S. Electric Grid*. U.S. Department of Energy. <https://www.energy.gov/sites/default/files/2022-10/Cybersecurity%20Considerations%20for%20Distributed%20Energy%20Resources%20on%20the%20U.S.%20Electric%20Grid.pdf>
- xcix. E-ISAC. 2023. *Welcome to the E-ISAC*. E-ISAC. <https://www.eisac.com/s/>
- c. National Energy Screening Project. *Database of Screening Practices*. <https://www.nationalenergyscreeningproject.org/state-database-dsp/>
- ci. Schwartz, L., & Frick, N. June 16, 2022. *State Regulatory Approaches for Distribution Planning*. Lawrence Berkeley National Labs. https://eta-publications.lbl.gov/sites/default/files/schwartz_state_distribution_planning_20220616.pdf
- cii. National Renewable Energy Laboratory. February 11, 2021. *NREL's dGen Analysts Team Up with Orlando Utilities Commission to Forecast Household Solar Adoption*.
- ciii. Nethercutt, E. J. January 2023. *Demand flexibility within a performance-based regulatory framework*. NARUC. <https://pubs.naruc.org/pub/2A466862-1866-DAAC-99FB-E054E1C9AB13>
- civ. Otter Tail Power Company. 2016. *OTPC IRP Resource Plan Appendix A: Plan Cross Reference*. Otter Tail Power Company. https://www.otpc.com/media/3647/irp_resource_plan_appendices.pdf
- cv. Pacific Gas and Electric Company. June 30, 2023. *Clean Energy Plan and Integrated Resource Plan 2023*. Pacific Gas and Electric Company. https://downloads.ctfassets.t/416ywc1aqmd/6B6HLox3jBzYLXOBg-skor5/63f5c6a615c6f2bc9e5df78ca27472bd/PGE_2023_CEP-IRP_RE-VISED_2023-06-30.pdf
- cvi. Fine, S., & Cook, P. December 14, 2022. *A Load Management Strategy: The Missing Link*. ICF. <https://www.icf.com/insights/energy/load-management-strategy-missing-link>
- cvi. Midcontinent Independent System Operator. April 14, 2022. *Order No. 2222 Compliance Filing*.
- cvi. Eisenhardt, H. September 12, 2022. *Minimum Capability Requirement for Individual Resources Participating in an Aggregation*. New York ISO. <https://www.nyiso.com/documents/20142/33125427/DER%20Minimum%20Capability%20Requirement.pdf/25832107-42fc-c063-572e-71f02bf814bd>
- cix. Solar Energy Technologies Office. N.d. *Revised IEEE 1547 standard will aid solar integration*. U.S. Department of Energy. <https://www.energy.gov/eere/solar/articles/revised-ieee-1547-standard-will-aid-solar-integration>
- cx. Hledik, R., Faruqi, A., Lee, T., & Higham, J. June 2019. *The National Potential for Load Flexibility*. The Brattle Group. https://www.brattle.com/wp-content/uploads/2021/05/16639_national_potential_for_load_flexibility_-_final.pdf